

Manual of Composting Toilet and Greywater Practice

Version 1

July 2016

Health Protection Branch

BC Ministry of Health

Developed in collaboration with the Applied Science Technologists and Technicians of British Columbia

Primary Author

Ian Ralston, B.Sc., Pg.Dip.Ag.Eng., ROWP, Eng.L

Technical and editorial review

Ann Baird BSc

Gord Baird BSc

Geoff Hill Phd

Ed Hoepfner ROWP

Michael Payne, M.Eng., P.Eng., P.Geo.

Mike Seymour Eng.L

Table of Contents

PART A	INTRODUCTION.....	9
A- 1	DEFINITIONS	9
A- 1.1	Glossary.....	9
A- 1.2	Table of acronyms.....	13
A- 2	PURPOSE AND SCOPE OF THE MANUAL	15
A- 2.1	Purposes of this Manual	15
A- 2.2	Scope and applicability.....	15
A- 3	ROLES AND RESPONSIBILITIES.....	16
A- 4	INSTRUCTIONS FOR USE OF THE MANUAL	17
A- 4.1	Sewerage System Standard Practice Manual	17
A- 4.2	Organization of the Manual	17
A- 4.3	Standards, guidelines and appendices	17
A- 4.4	Using the introduction and guidelines	18
A- 4.5	Application of the Manual by authorized persons	18
A- 4.5.1	This Manual as a source of standard practice	18
A- 4.5.2	Procedure standards and documentation	18
A- 4.5.3	Custom design.....	18
A- 5	INTRODUCTION TO COMPOSTING TOILET SYSTEMS	19
A- 5.1	The composting toilet system.....	19
A- 5.2	Path for materials in a composting toilet system	19
A- 5.3	Types of composting toilets and composting processes.....	21
A- 5.4	Discharge of composting toilet system residual organic matter.....	22
A- 6	INTRODUCTION TO SOURCE SEPARATED WASTEWATER SYSTEMS	23
A- 6.1	Source separated wastewater	23
A- 6.2	Summary of options	23
A- 6.2.1	Options for dispersal	23
A- 6.2.2	Seasonal sub irrigation dispersal systems	25
A- 6.2.3	Mulch basin systems	25
A- 6.2.4	Seasonal urine dispersal systems	25
A- 7	REGULATORY CONTEXT	25
A- 7.1	Composting toilet systems	25
A- 7.1.1	Sewerage System Regulation.....	25
A- 7.1.2	BC Building and Plumbing Code	25
A- 7.1.3	Discharge of residual organic matter	26
A- 7.1.4	Vault toilets	26
A- 7.2	Source separated wastewater systems	26
PART B	STANDARDS.....	27

B- 1	COMPOSTING TOILET SYSTEM STANDARDS	27
B- 1.1	Introduction	27
B- 1.2	Procedure standards.....	27
B- 1.2.1	Documentation and general standards	27
B- 1.2.2	Purposes and objectives	27
B- 1.2.3	Site use and waste characterization	27
B- 1.2.4	Site and soil evaluation	27
B- 1.2.5	System selection, specification and installation	27
B- 1.2.6	Filing and permitting.....	28
B- 1.2.7	Letter of Certification, maintenance plan, maintenance and monitoring	28
B- 1.3	System purpose and objectives standards	28
B- 1.3.1	Primary purposes of composting toilets	28
B- 1.3.2	Secondary purposes based on planned discharge method for residual organic matter	28
B- 1.4	System capacity standards.....	29
B- 1.4.1	System capacity.....	29
B- 1.4.2	Excreta volume.....	29
B- 1.5	System selection standards	30
B- 1.6	Specification and Installation standards	30
B- 1.7	Residual organic matter processing standards	33
B- 1.7.1	Incineration	33
B- 1.7.2	Curing.....	34
B- 1.7.3	On-site sanitizing or disinfection	35
B- 1.8	Discharge standards for residual organic matter.....	37
B- 1.8.1	Storage of residual organic matter.....	37
B- 1.8.2	Off-site discharge	37
B- 1.8.3	On-site discharge.....	37
B- 1.9	Maintenance standards	40
B- 1.9.1	health and Hygiene during Handling	40
B- 1.9.2	Processing of residual organic matter.....	40
B- 1.9.3	Maintenance	40
B- 2	SOURCE SEPARATED WASTEWATER SYSTEM STANDARDS.....	42
B- 2.1	Introduction	42
B- 2.2	Procedure standards.....	42
B- 2.2.1	Documentation and general standards	42
B- 2.2.2	Source characterization and design flows	42
B- 2.2.3	Source separated wastewater systems for seasonal irrigation.....	42
B- 2.2.4	Filing.....	42
B- 2.2.5	Maintenance plans.....	42

B- 2.3	Design flow standards	43
B- 2.3.1	Residential daily design flows.....	43
B- 2.3.2	Non-residential daily design flows.....	43
B- 2.4	Collection and treatment standards	44
B- 2.5	Effluent dispersal standards	47
B- 2.5.1	Hydraulic loading rates	47
B- 2.5.2	Mulch basin systems	48
B- 2.5.3	All season systems and seasonal sub irrigation systems.....	50
B- 2.5.4	Subsurface discharge and cover.....	50
B- 2.6	Maintenance standards	51
PART C	GUIDELINES	52
C- 1	COMPOSTING TOILET SYSTEM GUIDELINES	52
C- 1.1	Introduction	52
C- 1.2	Procedure guidelines	52
C- 1.2.1	Filing form.....	52
C- 1.2.2	Filing design flow and system treatment capacity.....	52
C- 1.2.3	Documentation.....	52
C- 1.3	System purpose and objectives guidelines	53
C- 1.3.1	Primary purposes.....	53
C- 1.3.2	Secondary purposes.....	53
C- 1.4	System capacity guidelines	54
C- 1.4.1	Introduction	54
C- 1.4.2	Volume variations, urine diversion and fecal separation systems.....	54
C- 1.4.3	Residential waste estimation.....	54
C- 1.4.4	Combined volume, with additives.....	57
C- 1.4.5	Public use site waste estimation.....	57
C- 1.4.6	Characteristics of collected wastes.....	57
C- 1.4.7	System capacity.....	59
C- 1.4.8	Vault toilets and dry toilets.....	62
C- 1.5	System selection guidelines	63
C- 1.5.1	Introduction	63
C- 1.5.2	Type of process	63
C- 1.5.3	General selection guidance	64
C- 1.5.4	Operation and maintenance and owner considerations.....	64
C- 1.5.5	Considerations for future site use.....	64
C- 1.6	Specification and Installation guidelines	64
C- 1.6.1	Introduction	64
C- 1.6.2	Composting toilet structures and the BC Building Code.....	65

C- 1.6.3	Pedestal seat.....	65
C- 1.6.4	Collection system, pedestal conveyance.....	65
C- 1.6.5	Collection system, container	65
C- 1.6.6	Ventilation	65
C- 1.6.7	Access for operation and maintenance	66
C- 1.6.8	Purpose and desired characteristics of bulking agents.....	66
C- 1.6.9	Non-excreta waste deposits.....	67
C- 1.6.10	Dry toilets.....	67
C- 1.6.11	Separate processors.....	68
C- 1.6.12	Separate open container processors	68
C- 1.6.13	Incinerating toilets.....	68
C- 1.6.14	Hand sanitizer	68
C- 1.6.15	Urine treatment	68
C- 1.6.16	Users and access	69
C- 1.7	Residual organic matter processing guidelines.....	69
C- 1.7.1	Introduction	69
C- 1.7.2	Health and hygiene precautions during processing and handling.....	69
C- 1.7.3	Assessing moisture content.....	69
C- 1.7.4	Guidelines for incineration.....	70
C- 1.7.5	Guidelines for curing	70
C- 1.7.6	Guidelines for on-site sanitizing or disinfection.....	70
C- 1.8	Discharge guidelines for residual organic matter.....	72
C- 1.8.1	Introduction	72
C- 1.8.2	Off-site discharge	74
C- 1.8.3	On-site discharge.....	74
C- 1.9	Maintenance guidelines.....	80
C- 1.9.1	Health and hygiene precautions during processing and handling.....	80
C- 1.9.2	Maintenance	80
C- 1.9.3	Owner involvement in operation and maintenance	80
C- 2	SOURCE SEPARATED WASTEWATER SYSTEM GUIDELINES.....	82
C- 2.1	Introduction	82
C- 2.2	Procedure guidelines.....	82
C- 2.2.1	Filing design flow.....	82
C- 2.3	Design flow guidelines.....	82
C- 2.3.1	Daily design flow selection	82
C- 2.3.2	Other daily design flows	83
C- 2.3.3	Source separated stream flows and characteristics	83
C- 2.4	Collection and treatment guidelines.....	85

C- 2.4.1	Introduction	85
C- 2.4.2	Urine collection and storage systems.....	85
C- 2.4.3	diversion collection systems.....	86
C- 2.4.4	Septic tank systems.....	87
C- 2.4.5	Type 2 and 3 treatment systems	88
C- 2.5	Effluent dispersal and sub-irrigation guidelines	89
C- 2.5.1	Hydraulic loading rates	89
C- 2.5.2	Mulch basin systems	90
C- 2.5.3	All season dispersal systems and seasonal sub irrigation systems.....	93
C- 2.5.4	Urine dispersal systems.....	95
C- 2.6	Maintenance guidelines.....	96
C- 2.6.1	Source control.....	96
C- 2.6.2	Urine collection system and storage tank.....	96
C- 2.6.3	Mulch management.....	97
C- 2.6.4	Owner involvement in operation and maintenance	98
PART D	APPENDICES.....	99
D- 1	PERFORMANCE OBJECTIVES AND RATIONALE	99
D- 1.1	Introduction	99
D- 1.2	Performance statements	99
D- 1.3	Performance objectives	99
D- 1.3.1	Risk objectives.....	99
D- 1.3.2	Composting toilets.....	100
D- 1.3.3	Composting toilet residual organic matter	101
D- 1.3.4	Hand hygiene	101
D- 1.3.5	Source separated wastewater systems.....	102
D- 1.4	Rationale for standards.....	103
D- 1.4.1	Composting toilets.....	103
D- 1.4.2	Composting toilet processors and residual organic matter management.....	104
D- 1.4.3	Source separated wastewater systems.....	109
D- 1.5	Bibliography	114
D- 2	DESIGN MANUALS AND ONLINE RESOURCES	121
D- 3	IN HOUSE GREYWATER REUSE FOR TOILET FLUSHING	123
D- 3.1	Introduction	123
D- 3.2	Recommended standards for greywater reuse	123
D- 3.3	Sewerage system standards for sites with greywater reuse	123
D- 3.4	Guidelines for greywater reuse.....	123
D- 3.5	Guidelines for sewerage systems for sites with greywater reuse	124
D- 4	BC BUILDING AND PLUMBING CODE AND COMPOSTING TOILETS.....	125

D- 4.1	Objective based code	125
D- 4.2	Part 3 buildings and composting toilets	125
D- 4.3	Part 3 buildings and lavatories	126
D- 4.3.1	Intent, functional statements and objectives relating to section 3.7.2.3	126
D- 4.3.2	Recommended alternative solution	127
D- 4.3.3	Alternative solution meets intent, functional statements and objectives	127
D- 4.4	BC Building Code Section 9.31	127
D- 4.4.1	Intent, functional statements and objectives relating to section 9.31	128
D- 4.4.2	Recommended alternative solution	129
D- 4.4.3	Standard practice.....	129
D- 4.4.4	Alternative solution meets intent, functional statements and objectives	129
D- 4.4.5	Summary	131
D- 5	OPERATION VERSUS MAINTENANCE FOR COMPOSTING TOILET SYSTEMS.....	132
D- 6	SUMMARY FOR ENVIRONMENTAL HEALTH OFFICERS.....	133
D- 6.1	Introduction	133
D- 6.1.1	Sewerage system regulation	133
D- 6.2	Onsite waste management	133
D- 6.3	Composting toilet system filings.....	133
D- 6.3.1	Primary purposes of composting toilet systems	134
D- 6.3.2	Composting toilet system filings	134
D- 6.4	Source separated wastewater system filings	135
D- 6.4.1	Source separated wastewater system filings	135

Part A Introduction

A- 1 DEFINITIONS

A- 1.1 Glossary

The glossary includes only those specialized terms used in this Manual and not otherwise defined by regulation or by the Sewerage System Standard Practice Manual (SPM).

A

Aerobic: Having molecular oxygen as a part of the environment, or growing or occurring only in the presence of molecular oxygen, as in "aerobic composting."

Aerobic (composting process): Molecular oxygen content in all parts of the compost over 5%.

Anaerobic: Characterized by the absence of molecular oxygen, or growing in the absence of molecular oxygen (as in "anaerobic digestion").

Additives (composting toilets): Bulking agents, fermentation additives or other amendments added to composting toilet pedestals or processors.

All season system (greywater): A greywater or source separated wastewater system planned to treat and disperse wastewater throughout the year.

B

Batch process (composting processor): A composting processor which takes materials through one or more steps of the composting process in a discrete container or pile, without further addition of excreta.

Blackwater: Source separated wastewater from water closets (flush toilets).

Brownwater: Source separated feces, toilet paper and water from water closets (without urine).

Bulking agent: Material, commonly carbonaceous, added to collected excreta for the purpose of improving structure, creating porosity, absorbing liquid, controlling odor and, in some cases, adding carbon.

C

C:N ratio (organic matter): Carbon to nitrogen ratio of composting toilet organic matter (excreta and or additives). Calculated as the ratio of the mass of carbon to the mass of nitrogen in the material, typically as % carbon ÷ % nitrogen, with percentages on a dry weight bases.

Container collection system: A collection system for excreta or wastewater which involves collecting the material in a container and physically transporting it to a separate processor (treatment system).

Continuous process (composting processor): A composting processor which takes materials through one or more steps of the composting process with ongoing addition of excreta. Typically, a single compartment, with addition of material at the top or end and withdrawal of processed material at the base or end.

Combined sewage wastewater system: A wastewater system receiving all wastewater flows from a building.

Commode: A composting toilet pedestal with container collection system.

Compost: Solid, stable, safe, mature product resulting from composting. Composting toilet residual organic matter is **not** compost.

Composting: Managed process of bio-oxidation of a solid heterogeneous organic substrate including a thermophilic phase of specific minimum time and minimum temperature followed by a curing step. For the purpose of this Manual “composting” process is used to refer to stages or steps of the overall composting toilet process, in some cases taken in isolation.

Composting toilet: A composting toilet system meeting the primary objectives established by this Manual. For the purpose of this Manual, includes incinerating toilets.

Composting toilet additive: Any material added to the composting toilet collection system or processor to assist with function or to maintain operational conditions. See *bulking agent*.

Composting toilet system: A human waste receptacle (composting toilet pedestal) into which human waste and toilet paper are deposited, collected and conveyed, in the absence of conventional flush water (by the composting toilet collection system), to an on-site aerobic digestion and storage system (composting toilet processor), within which some means of ‘treatment’ is imposed. The treatment imposed can include one or more of the following: desiccation, stabilization, sanitization.

Curing (composting toilet residual organic matter): A resting period for moist residual organic matter, in aerobic conditions, at ambient temperature for a specified period. Also termed “maturation” or “vector attraction reduction”.

D

Daily design flow (for source separated wastewater): Estimated peak ground discharge flow, used in filing documentation.

Daily design volume (for solid wastes): Estimated volume of excreta for peak week usage, expressed as a 7 day daily average volume.

Dark greywater: Greywater flowing from kitchen, dishwashing and mop sink uses.

Desiccation: The process of dehydration (drying) of excreta or leachate for odor control, pathogen attenuation and volume reduction.

Diversion: Separation of waste at source or in a collection system. See greywater diversion.

Diverted urine: Urine collected from a diversion system, which may contain fecal contamination.

Dry toilet: A toilet pedestal and collection system with container used to desiccate fecal matter.

E

Excreta: For the purpose of this Manual excreta includes feces, toilet paper and urine. More generally, waste matter discharged from the body.

F

Foreign matter: Any matter over 2 mm in dimension that results from human intervention and has organic or inorganic components such as metal, glass, synthetic polymers.

G

Greywater: Waterborne waste from the preparation of food and drink, dishwashing, bathing, showering and general household cleaning and laundry. See also, Dark greywater, Light greywater, Very light greywater. Greywater does not mean "reclaimed water".

Greywater diversion system: A sanitary drainage system planned or modified to allow optional diversion of one or more greywater streams from the combined wastewater flow.

Greywater seasonal diversion system: For the purposes of this Manual, a system allowing for seasonal diversion of light greywater for subsurface irrigation use.

H

Headspace (container): Additional storage volume or freeboard over and above minimum required volume of a container.

L

Laundry greywater: Greywater flowing from washing machines and laundry sinks.

Leachate: liquid effluent which is managed and or discharged by a composting toilet or composting toilet processor.

Light greywater: Greywater flowing from uses other than kitchen, dishwashing or mop sinks. Example, shower water or laundry greywater.

M

Maturation (composting toilet residual organic matter): See "curing".

Maturity (composting toilet residual organic matter): The agricultural or soil amendment value or impact of the residual organic matter., Represented by reduction of phytotoxic compounds and ammonia. Maturation occurs after initial digestion and stabilization. Maturity is affected by *stability*, but also represents the impact of compost chemical properties on plant development and soil organisms. For example, high levels of ammonia which can impact seed germination or root development. See *stability*.

Mesophilic (temperature): Temperature in the range 20 to 40 C.

Mesophilic phase (composting process): Biological phase in the composting process characterized by the presence of microorganisms which grow optimally in a temperature range of 20 C to 45 C.

Microaerobic (fermentation process): Fermentation in a very low molecular oxygen content environment.

Mulch basin: Dispersal and subsurface irrigation technique for light greywater from small flow residential seasonal diversion systems. A shallow basin or bed with mulch media below the infiltrative surface.

Multiple barrier (multi barrier) risk management (for this Manual): A barrier is a part of the treatment or handling chain of an onsite sewerage system which either reduces pathogen levels in excreta, residual material or effluent, or which reduces the risk of human exposure to pathogens. The standards of this Manual are based on providing multiple barriers to pathogen risk from the use, operation and maintenance of composting toilet and greywater sewerage systems.

O

On-site burial (composting toilet residual organic matter): Subsurface discharge of residual organic matter by burial following the standards of this Manual.

On-site surface discharge (composting toilet residual organic matter): Surface discharge (including incorporation to the surface soil) of residual organic matter following the best practice guidelines of this Manual.

P

Packaging toilet: Toilet pedestal that packages excreta in bags for conveyance to disposal or a composting processor.

Prill (urea): Small, soft granule of urea.

Psychrophilic (temperature): Temperature in the range -10 to 20 C.

Psychrophilic (composting process): Ambient temperature processing. Dominant temperature regime for mouldering composting toilet processors and may also occur during late stage curing.

R

Residual organic matter: The solid waste end product that emerge from or are removed from a composting toilet processor. Residual organic matter is **not** compost.

S

Secondary composting: Additional retention and aerobic decomposition of residual organic matter to meet specified curing period.

Sharp foreign matter: Any foreign matter over a 3 mm dimension that may cause damage or injury to humans and animals during or resulting from its intended use.

Site built: Constructed at the site of use. For this Manual refers particularly to composting toilet systems and composting toilet processors that are built following an open source design.

Source control: For this Manual, a defined acceptable wastewater quantity and quality which the sewerage system can receive, treat and disperse while meeting performance objectives. May also include definition of unacceptable contaminants or conditions.

Source separation: Separation of wastes into specific types of material at the point of generation.

Source separated wastewater: Waste water stream that has been discharged from the building by a separate sanitary drainage or collection system, or has been separated from solids. Includes greywater, diverted urine, water separated from blackwater and leachate. Includes diversion and separated greywater sanitary drainage systems.

SPM equivalent combined sewage DDF: Daily Design Flow (DDF) estimated for the proposed site use following the standards and guidelines of the SPM, or a custom DDF developed by a professional.

Stability (composting toilet residual organic matter): A specific stage of decomposition during composting. Highly stabilized compost will have low or no odor, will not tie up nutrients in soil and will not reduce oxygen availability.

Struvite: Magnesium ammonium phosphate (MAP), which precipitates from urine.

T

Thermophilic (temperature): Temperature above 35 C.

Thermophilic phase (composting process): Biological phase in the composting process characterized by the presence of microorganisms which grow optimally in a temperature range of 45 C to 75 C.

U

Urea (fertilizer): A solid commercial nitrogen fertilizer (CH₄N₂O), used in sanitizing of residual organic matter as described in this Manual.

V

Vector attraction reduction (composting toilet residual organic matter): See "curing".

Very light greywater: Wastewater from showers, baths, hand basins. Light greywater excluding laundry water.

Volatile solids (organic matter): Components (primarily carbon, oxygen and nitrogen) which burn off in an already dry sample in a furnace at 500 to 600 C, leaving ash.

W

Water closet (WC): Flush toilet using conventional flush volume.

Water separated from blackwater: For the purpose of this Manual water separated from blackwater refers to water separated by filtration or centrifugal methods from blackwater or brownwater streams.

A- 1.2 Table of acronyms

ABBREVIATION	FULL TEXT
AIS	Area of Infiltrative Surface
AP	Authorized Person
APEGBC	Association of Professional Engineers and Geoscientists of BC
ASTTBC	Applied Science Technicians and Technologists of BC
BCBC	BC Building and Plumbing Code
BOD or BOD ₅	Biochemical Oxygen Demand (5 day)
CAN/BNQ	National Standard of Canada/Bureau De Normalisation Du Quebec
CCME	Canadian Council of Ministers of Environment
CCQC	California compost Quality Council
COD	Chemical Oxygen Demand

ABBREVIATION	FULL TEXT
CFUs	Coliform Forming Units
DDF	Daily Design Flow
DGW	Dark greywater
FOG	Fats, Oils, Grease (also known as O&G)
HAR	Hydraulic Application Rate
HLR	Hydraulic Loading Rate
HS	Horizontal separation
Kfs	Field Saturated Hydraulic Conductivity
LGW	Light greywater
LLR	Linear Loading Rate
MPN	Most Probable Number
ROWP	Registered Onsite Wastewater Practitioner
SDD	Subsurface Drip Dispersal
SHWT	Seasonal high water table
SPM	BC Sewerage System Standard Practice Manual, Version 3
SSR	Sewerage System Regulation
TSS	Total Suspended Solids
USDA	United States Department of Agriculture
USEPA	United States Environmental Protection Agency
VS	Vertical Separation
WC	Water closet (flush toilet)
WHO	World Health Organization

A- 2 PURPOSE AND SCOPE OF THE MANUAL

This Manual provides semi-prescriptive standards based on the achievement of performance criteria as supported by research for the planning, installation and maintenance of composting toilet systems and source separated (greywater) systems.

The result of using the standards and guidelines is that systems, when properly operated, will meet or exceed defined performance objectives.

A- 2.1 Purposes of this Manual

The primary purpose of this Manual is to provide minimum standards and guidelines for planning, installation, monitoring and maintenance of composting toilet and greywater systems that will protect human health and the environment.

These standards and guidelines are intended to result, if applied, in the system meeting the performance statements and objectives established in the Appendix Part D of this Manual.

This Manual is not intended to educate readers about composting toilets, greywater systems and source separated wastewater systems, nor is it intended to be a design manual. This is a technical manual, intended for use by Authorized Persons.

The design and specification standards of this Manual are limited to the selection and application of public domain standard designs (open source designs) and techniques or to the selection of commercial systems.

A- 2.2 Scope and applicability

This Manual applies to planning, installation and maintenance of composting toilets and source separated wastewater (including greywater) systems as onsite sewerage systems under the Sewerage System Regulation (SSR).

An Authorized Person (AP) may refer to this Manual as a source of standard practice as defined by the SSR.

This Manual does not repeat standards and guidance for the planning, installation and maintenance of onsite sewerage systems found in the BC SPM Version 3 and the APEGBC Professional Practice Guidelines, Onsite Sewerage Systems.

Activities must not contravene the Environmental Management Act. Particularly, on-site surface discharge of composting toilet system residual organic matter must not cause pollution and greywater (treated or un treated) is not to be considered to be reclaimed water under the Municipal Wastewater Regulation unless the requirements of that regulation are met.

A- 3 ROLES AND RESPONSIBILITIES

Table A- 1. Regulatory roles and responsibilities

ORGANIZATION OR STAKEHOLDER	ROLE
Ministry of Health	Responsible for the SSR, maintenance of the BC SPM and of this Manual. Establishes policy for interpretation of the SSR and for Health Authorities.
Health Authorities and Environmental Health Officers (EHOs)	Administration of filings. Administration and enforcement of the SSR and the <i>Public Health Act</i> . Investigation and compliance action for the prevention or correction of potential health hazards caused by onsite systems. Receives and responds to complaints about potential health hazards.
Ministry of Environment	Responsible for the <i>Environmental Management Act</i> .
Ministry of Natural Gas Development and Responsible for Housing	Responsible for the BC Building Code and BC Plumbing Code.
Health Canada	Responsible for Canadian Guidelines for Domestic Reclaimed Water for Use in Toilet and Urinal Flushing.
Local government building inspectors	Responsible for application of the BC Building and Plumbing Code, and for approval of alternate solutions.
Association of Professional Engineers and Geoscientists of BC (APEGBC)	APEGBC regulates the practice of its members and licensees, including those practicing in the area of onsite sewerage systems.
Applied Science Technologists and Technicians of British Columbia (ASTTBC)	Registers and regulates the practice of ROWPs
Authorized Persons (Professional or ROWP)	Responsible for the planning, installation and maintenance of a sewerage system in accordance with standard practice.
System Owner	Required by law to retain an AP (professional or ROWP) to plan, install and maintain the sewerage system (or supervise same), as outlined in the SSR. Responsible for operation and maintenance of the system, including retaining an AP to undertake maintenance of the system. The system owner may be involved with system installation and maintenance under AP supervision as per SSR section 6(1) (b) and 6(3).

See the SPM for further information on regulatory context, Authorized Persons, organizations and stakeholders.

A- 4 INSTRUCTIONS FOR USE OF THE MANUAL

A- 4.1 Sewerage System Standard Practice Manual

This Manual has been developed to be consistent with the BC Sewerage System Standard Practice Manual Version 3 (SPM), and the standards are supplemental to standards and guidelines in the SPM.

Use this Manual with the SPM, following SPM standards except where specifically modified or adapted by this Manual. **Do not attempt to use this Manual without reference to the SPM.**

A- 4.2 Organization of the Manual

This Manual is organized into separate parts, which may be printed as separate volumes:

- Part A Introduction and scope; provides an overview of the Manual and an introduction to composting toilet and greywater systems. Includes the glossary and provides regulatory context.
- Part B Standards; providing standards for application of composting toilet and source separated wastewater systems:
 - B-1, Standards for composting toilet systems
 - B-2, Standards for source separated wastewater systems
- Part C Guidelines; providing guidelines for application of composting toilet and source separated wastewater systems:
 - C-1, Guidelines for composting toilet systems
 - C-2, Guidelines for source separated wastewater systems
- Part D Appendices; providing background information and resources:
 - D-1, Rationale and references supporting key standards of Parts B
 - D-2, A list of useful design manuals and online resources.
 - D-3, Guidelines for in house re-use of greywater for toilet flushing
 - D-4, Information on use of composting toilets under the BC Building Code
 - D-5, An introduction to the Manual and filing documentation for Environmental Health Officers.

A- 4.3 Standards, guidelines and appendices

For the purposes of this Manual:

- Standards are the minimum instructions, processes, criteria or specifications which are established to result, if applied, in the performance outcomes defined by this Manual.
- Guidelines provide instructions or advice on how to meet or use the standards. They also provide examples, additional recommended practice and specialized guidance.
- Appendices are additional recommended reading and supporting material.

A- 4.4 Using the introduction and guidelines

Use Part A alongside Part B to help in understanding system terminology and options, and also for regulatory context when planning a system.

Use Part C (guidelines) of the Manual alongside Part B (standards). In this way the guidelines can be read at the same time as the standards.

Main standards sub-sections in Part B have associated guideline sub-sections in Part C. These sections are not cross referenced. The major standards sub-sections (e.g. B 1.5) have corresponding sub-section numbers in the guidelines, with the same sub-section number (e.g. C 1.5).

A- 4.5 Application of the Manual by authorized persons

Authorized Persons (AP) must comply with the Sewerage System Regulation, the *Environmental Management Act* and other applicable provincial and federal acts and regulations.

A- 4.5.1 THIS MANUAL AS A SOURCE OF STANDARD PRACTICE

Where an AP has identified this Manual as his or her source of standard practice:

- The AP is to follow the sections designated as standards.
- Departures from the sections designated guidelines are to be supported by written rationale.
- The Appendix Part D performance statements and objectives are to be considered in any cases where the AP is departing from the guidelines of the Manual.

A- 4.5.2 PROCEDURE STANDARDS AND DOCUMENTATION

Procedure standards indicate the minimum steps for site evaluation, planning, installation, monitoring and maintenance of systems.

Where guidance is needed for the procedure standards of this Manual, refer to the SPM.

A- 4.5.3 CUSTOM DESIGN

Custom site and project specific performance based design by a professional is an alternative to following the standards of this Manual.

Professionals follow the performance based design approach of the APEGBC Professional Practice Guidelines, Onsite Sewerage Systems. Appendix Part D of this Manual provides minimum performance objectives which may be used for performance based design.

A- 5 INTRODUCTION TO COMPOSTING TOILET SYSTEMS

A- 5.1 The composting toilet system

Figure A- 1 illustrates the basic components that make up a composting toilet system.

Figure A- 1. Composting toilet system

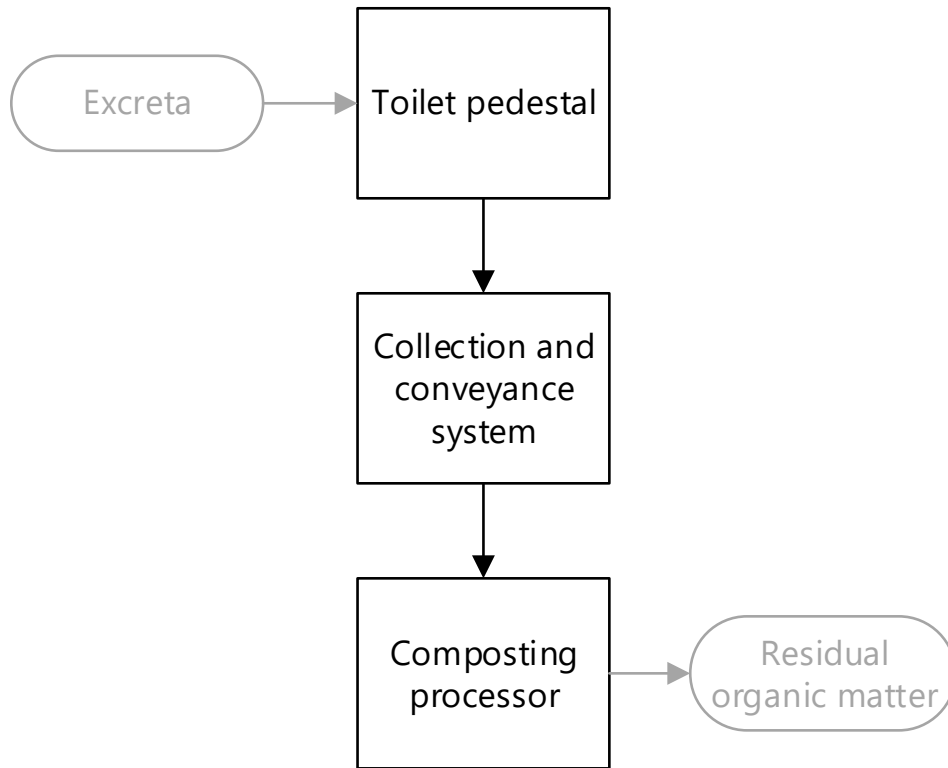

A- 5.2 Path for materials in a composting toilet system

Figure A- 2 shows options for the flow of materials in a composting toilet system. Figure C- 1 on page 73 is a flow chart that shows details of options for processing and discharging residual organic matter.

Figure A- 2. Composting toilet flow path

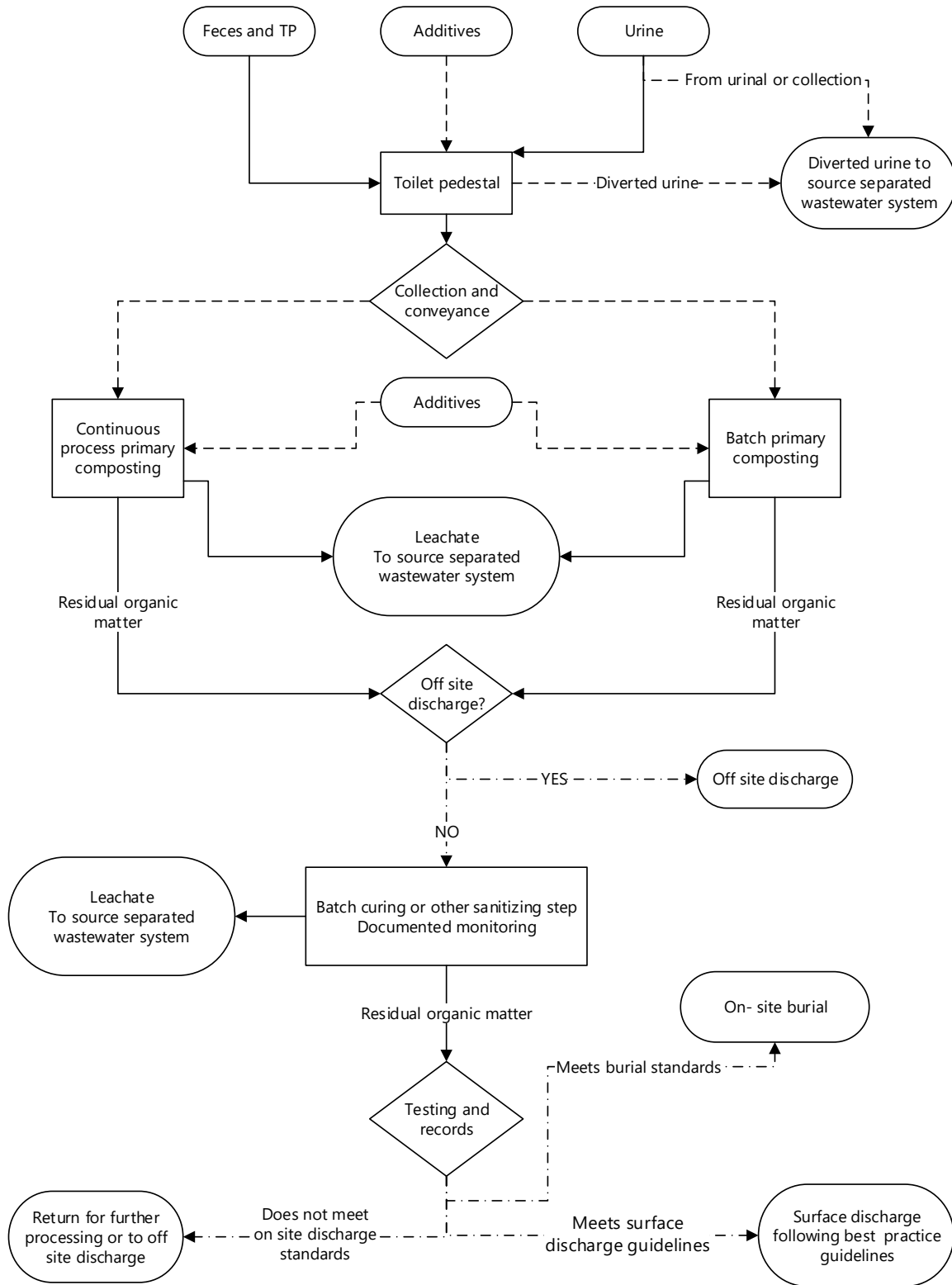

The standards for planning, installation and maintenance of composting toilet systems are arranged in the following steps:

- Project-specific purposes and objectives for the composting toilet system, Section B- 1.3
- Excreta characteristics and design values, sizing of the system and processor, Section B- 1.4
- Selection of the composting toilet system, Section B- 1.5
- The composting toilet unit including any collection or transfer system and processor, Section B- 1.6
- The composting process, Section B- 1.7
- Discharge of residual organic matter, Section B- 1.8
- Maintenance of the composting toilet system, Section B- 1.9

A- 5.3 Types of composting toilets and composting processes

Figure A- 3. Example of a batch process composting toilet

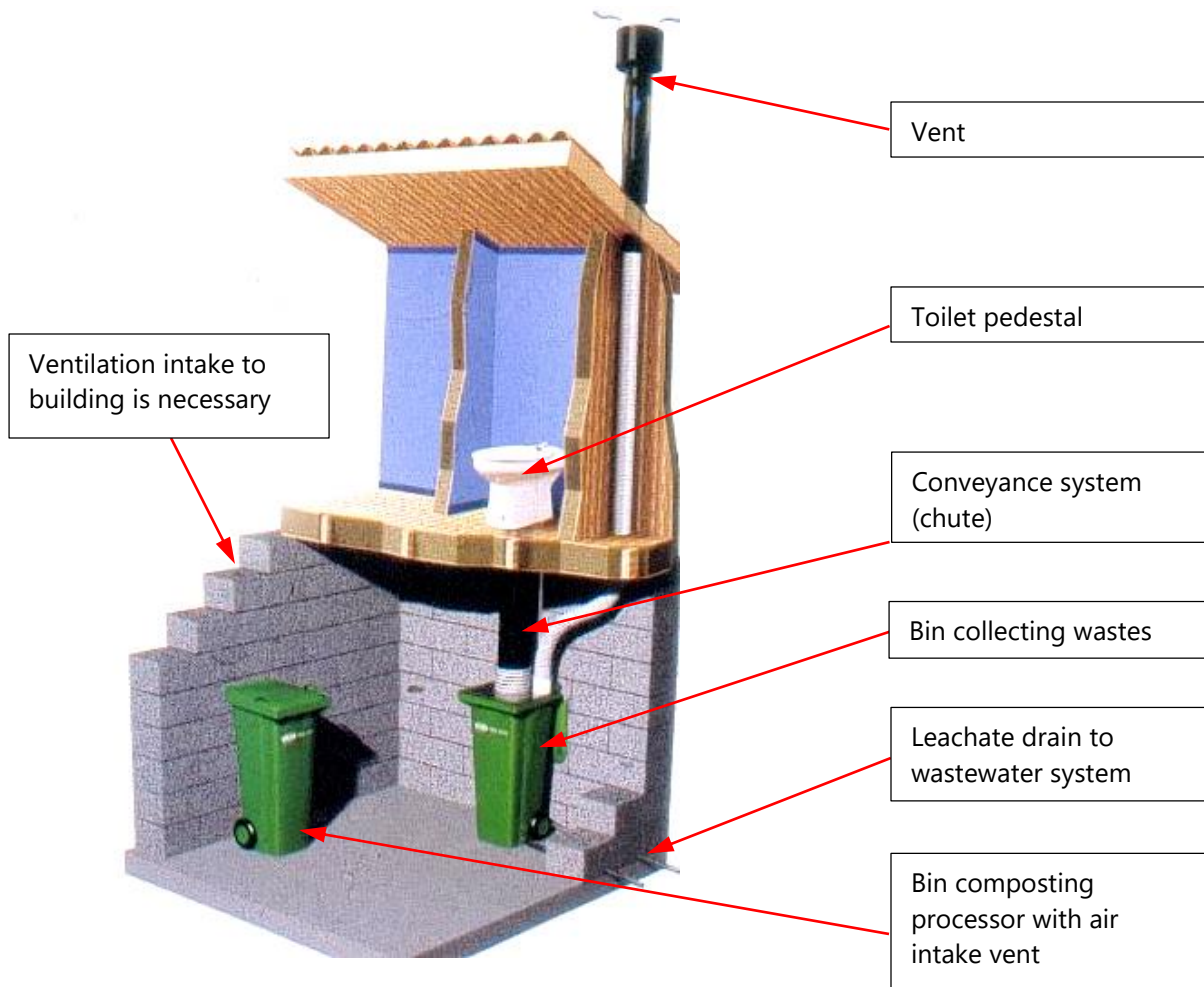

Image, University of Applied Sciences Zurich, Norwegian University of Life Sciences

Composting toilets use one of the two following composting processes:

- Batch composting
- Continuous process composting

Composting toilets are divided to:

- Commode or container collection systems, with collection of excreta and batch composting in a separate compost processor.
- Batch systems which collect material in a bin or container and then process the material in the same container in a separate location. Figure A- 3 illustrates an example of this system.
- In situ (chamber) composting systems, where composting occurs in the toilet or in a processor attached to the toilet.

For the purpose of this Manual composting toilet systems include incinerating toilets. Incinerating toilets use a heat source (e.g. propane) to burn excreta to ash.

A- 5.4 Discharge of composting toilet system residual organic matter

The following options are available for discharge of the residual organic matter from a composting toilet system:

- Discharge off site to an authorized facility (pump out or other form of transport)
- On-site discharge, consisting of either:
 - On-site burial; or
 - On-site surface discharge

See Section C- 1.8, Page 72, for further information on discharge options.

A- 6 INTRODUCTION TO SOURCE SEPARATED WASTEWATER SYSTEMS

A- 6.1 Source separated wastewater

When composting toilets are used to manage the human waste from a building, wastewater flows from the building are handled by a source separated wastewater system.

Diversion systems separate wastewater into specified streams at source. Diversion may be year round or seasonal.

Table A- 2 lists wastewater streams. These streams may be separated individually, or partially combined.

Table A- 2. Source separated streams

ABBREVIATION	CATEGORY	DESCRIPTION
Laundry greywater		Washing machine and laundry sink
LGW	Light greywater	Bathtubs, showers, bathroom sinks and laundry
VLGW	Very light greywater	Bathtubs, showers, bathroom sinks
DGW	Dark greywater	Dishwasher and kitchen sink, bar sinks, mop sinks
CGW	Combined greywater	All residential wastewater except water closets (flush toilets) and urinals
Blackwater		Water closets (flush toilets) and urinals only
Brownwater		Water closets (flush toilets), with urine diverted
Water separated from blackwater		Water separated from the blackwater or brownwater stream
Urine		Urinals and or diverted urine
Leachate		Leachate collected from composting processors
Combined sewage		Blackwater and greywater

System planning, installation and maintenance follows the SPM standards and also the standards of this Manual depending on the type of wastewater.

A- 6.2 Summary of options

A- 6.2.1 OPTIONS FOR DISPERSAL

Figure A- 4 illustrates options for dispersal. The diagram does not show Type 2 or 3 treatment options. For seasonal diversion systems, discharge to a public sewer is an alternative to an all season greywater system or all season sewerage system.

Figure A- 4. Options for source separated wastewater effluent dispersal

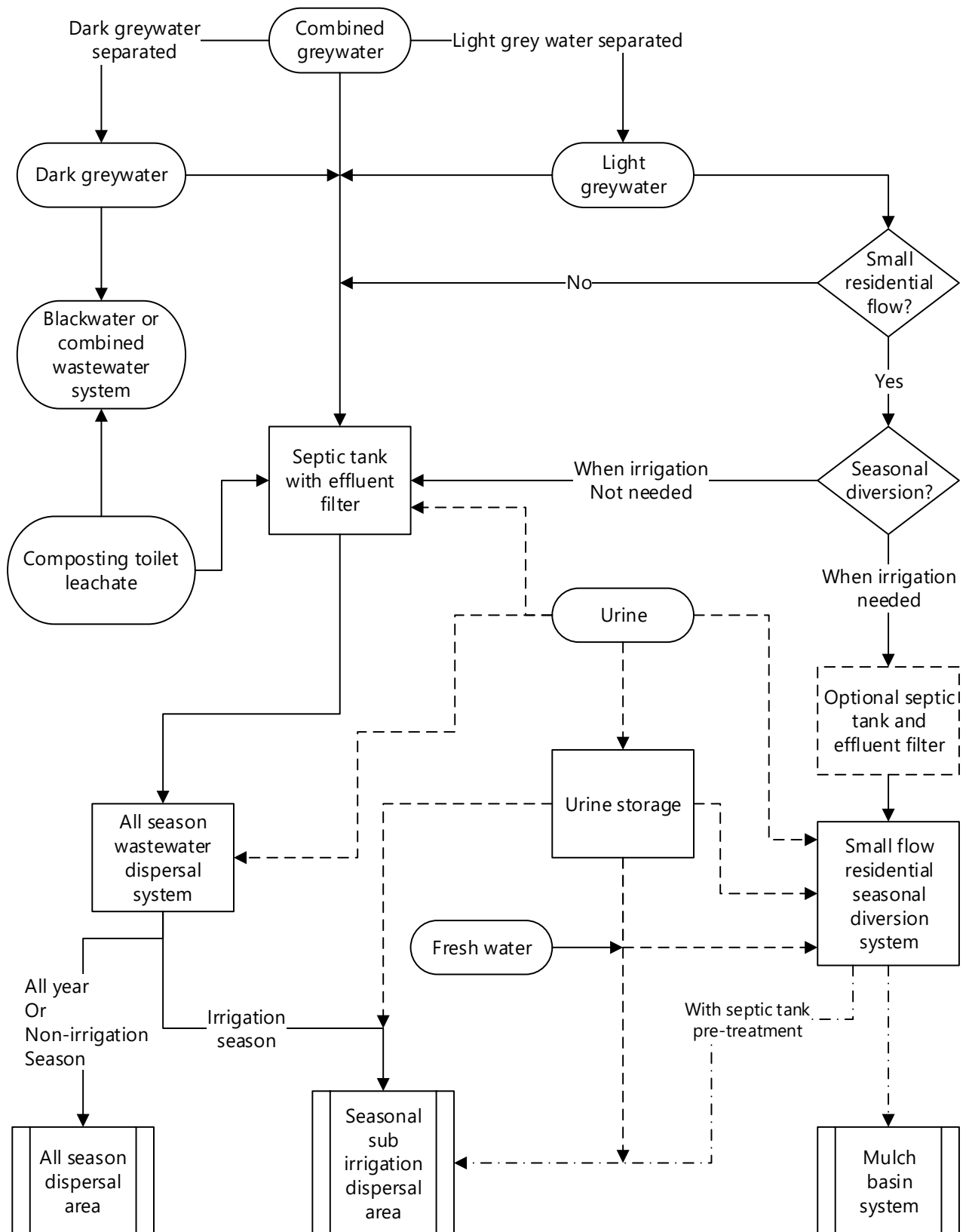

A- 6.2.2 SEASONAL SUB IRRIGATION DISPERSAL SYSTEMS

In a seasonal sub irrigation system source separated wastewater effluent is diverted to subsurface irrigation during the irrigation season. This type of system may be used in parallel with an all season greywater system, a combined sewerage system or a sewer connection.

Sub-irrigation system components are the same as for an all season system, but the system is planned with a specific irrigation objective.

A- 6.2.3 MULCH BASIN SYSTEMS

Mulch basin systems may be used for seasonal light greywater diversion, following the standards of this Manual.

During the irrigation season, the source separated light greywater may be diverted to subsurface irrigation using mulch basins, with or without septic tank treatment. Stored or fresh urine may be added to the greywater.

When irrigation is not needed the greywater is combined with other wastewater, and flows to the all season source separated wastewater system, sewerage system or to a public sewer connection.

A- 6.2.4 SEASONAL URINE DISPERSAL SYSTEMS

In this type of system, the urine is stored. Storage sanitizes the urine. Then, in the irrigation season, stored urine is diluted and dispersed by sub irrigation to mulch basins or other dispersal methods.

A- 7 REGULATORY CONTEXT**A- 7.1 Composting toilet systems****A- 7.1.1 SEWERAGE SYSTEM REGULATION**

This Manual identifies composting toilets (including pedestal, collection and conveyance system and processor) as part of a "sewerage system". The composting toilet system will be filed as part of a Sewerage System Regulation (SSR) filing for the site.

For systems receiving flow that would, for a water-borne system, result in an SPM equivalent combined sewage DDF of over 9100 L/day, the composting toilet system is to be planned, constructed and maintained by or under the supervision of a professional, as required by the SSR.

A- 7.1.2 BC BUILDING AND PLUMBING CODE

Composting toilets are presented by this Manual as an alternative solution to a water closet and associated sanitary drainage piping. The Appendix D- 4 documents this alternative solution under the BC Building and Plumbing Code (BCBC).

Primary purposes (objectives) for composting toilet systems are based on BCBC functions and objectives, and are stated in Section B- 1.3.1.

When working with local government officials as part of a building permit process, provide them with a copy of the Appendix D- 4. Provide a summary of the system selection rationale for the specific system, relating to the primary purposes in Section B- 1.3.1.

A- 7.1.3 DISCHARGE OF RESIDUAL ORGANIC MATTER

This Manual provides the following options for discharge of residual organic matter:

- Discharge off site to an authorized facility (pump out or other form of transport)
- On-site discharge:
 - On-site burial
 - On-site surface discharge (including incorporation to surface soils)

Off-site discharge (removal off site) is similar to the pump out of a septic tank and is identified in the filed system maintenance plan.

On-site burial is approached as for sub surface ground discharge of other effluent, and requires a filing and maintenance plan in conformance with the SSR.

On-site surface discharge requires compliance with the *Environmental Management Act*, particularly with the requirement that a person must not introduce waste into the environment in such a manner or quantity as to cause pollution. This Manual provides best practice guidance for on-site surface discharge, for small flow residential composting toilet systems.

A- 7.1.4 VAULT TOILETS

Vault toilets are toilets constructed over an impermeable vault which receives and holds excreta. The accumulated material is pumped out and taken to an approved facility off site.

If a vault or dry toilet is used as a collection system for an on-site composting process the vault or dry toilet is part of the composting toilet system.

Follow composting toilet system specification and installation standards (Section B- 1.6) for vault toilet system pedestals and collection systems.

A- 7.2 Source separated wastewater systems**A- 7.2.1.1 BC Building and Plumbing Code**

Source separation plumbing systems must comply with the BC Plumbing Code.

In the case of non-residential buildings with no water supply (e.g. a composting toilet at a remote trail), fixtures are not required. In these cases, other means of providing for wastewater collection and for personal hygiene should be provided for use with a composting toilet installation. This may include solutions such as container collection of urine and leachate or spray hand sanitizer for personal hygiene.

A- 7.2.1.2 Sewerage System Regulation

Source separated wastewater systems with daily design flows of less than 22.7 m³/day (and meeting other standards of the SSR) are sewerage systems under the SSR. Re-use of reclaimed water, including reclaimed greywater, is managed under the MWR and is not covered by this Manual.

Source separated wastewater systems are planned, installed and maintained to meet the SSR, with filing and documentation as for any other sewerage system. Refer to the SPM for further information on regulatory context for sewerage systems.

Part B Standards

B- 1 COMPOSTING TOILET SYSTEM STANDARDS

B- 1.1 Introduction

Section B- 1 contains this Manual's standards of practice for the application of composting toilets in BC. Section B- 2 contains the standards for source separated wastewater, including greywater, leachate and urine.

See the Appendix Part D for the performance basis of these standards. See the Appendix D- 2 for design manuals.

B- 1.2 Procedure standards

When planning, documenting, installing and maintaining a composting toilet system, follow these procedures.

B- 1.2.1 DOCUMENTATION AND GENERAL STANDARDS

- Document calculations and rationale and include a summary with the filing documentation.
- Meet standards of the SSR, this Manual and the SPM.

B- 1.2.2 PURPOSES AND OBJECTIVES

- Establish the planned discharge method for residual organic matter
- Define secondary purposes and objectives for the composting toilet system, including performance objectives for residual organic matter

B- 1.2.3 SITE USE AND WASTE CHARACTERIZATION

- Record the building use and occupancy, and SPM equivalent combined sewage daily design flow, following the procedure standards of the SPM.
- Estimate excreta and waste volumes and characteristics (Section B- 1.4)
- Calculate collection system and composting processor capacity (*as part of system selection*)

B- 1.2.4 SITE AND SOIL EVALUATION

- If the plan is to discharge residual organic matter on-site, follow the SPM standards for site and soil evaluation.

B- 1.2.5 SYSTEM SELECTION, SPECIFICATION AND INSTALLATION

- Select a composting toilet system that will meet the purposes and objectives.
- Specify a process to meet the standards of Section B- 1.8 for the chosen discharge option.
- Specify size and capacity of system components, including collection system and processor (Section B- 1.4.1)
- Specify system components to meet the defined purposes and objectives (Section B- 1.3) and the standards of Section B- 1.6
- Install and commission system components to meet the standards of Section B- 1.6

B- 1.2.6 FILING AND PERMITTING

- Obtain approval from local government building inspection officials for substitution of a composting toilet for a water closet, if the building permit needs this approval.
- Instruct the owner on how to work the composting toilet system.
- Prior to completion of the filing, confirm that the owner will take responsibility for proper operation and management of the system.
- File the composting toilet system with the regional Health Authority, under the SSR.
- Include information on any existing sewerage system used to accept wastewater flows from the site.

B- 1.2.7 LETTER OF CERTIFICATION, MAINTENANCE PLAN, MAINTENANCE AND MONITORING

- Write a maintenance plan for the system (Section B- 1.9)
- File the final documentation for the composting toilet system with the regional Health Authority.
- During maintenance and monitoring, document how the system is working compared to the original performance specifications.
- File amended maintenance plans when necessary to document changes to maintenance requirements, system process or operation of the system.
- If the discharge method for residual organic matter is to be changed from off-site discharge to on-site discharge, then make a new filing with the Health Authority.

B- 1.3 System purpose and objectives standards**B- 1.3.1 PRIMARY PURPOSES OF COMPOSTING TOILETS**

Select, specify, install and maintain the composting toilet and processor to meet the following primary purposes:

- Safely and hygienically collect and contain human waste
- Manage odors and prevent vector or human access during storage
- Manage leachate and safely discharge leachate or diverted urine to a combined or source separated wastewater sewerage system
- Provide for safe and practical management of residual organic matter.

B- 1.3.2 SECONDARY PURPOSES BASED ON PLANNED DISCHARGE METHOD FOR RESIDUAL ORGANIC MATTER

Define secondary objectives for the composting process and residual organic matter quality:

- For off-site discharge, define any planned secondary objectives.
- For on-site discharge, define planned secondary objectives, to meet the standards of Section B- 1.8, for the selected discharge method:
 - Objectives for residual organic matter quality; and
 - Performance and documentation standards for the process.

B- 1.4 System capacity standards

B- 1.4.1 SYSTEM CAPACITY

When specifying the composting toilet system collection and processing components:

- Estimate the volume and characteristics of excreta following Section B- 1.4.2.
- Estimate the volume and characteristics of any added bulking agents or admixtures (Section C- 1.4.6).
- Estimate the characteristics of the combined waste, if necessary for the chosen process.
- Calculate and specify the required composting toilet system capacity to serve the combined design volume. Ensure that the capacity meets the average and peak usage.
- Estimate the volume and characteristics of leachate or diverted urine that will be discharged to the wastewater system.
- For composting toilet processors, consider volume reduction where applicable.

B- 1.4.2 EXCRETA VOLUME

Estimate the minimum excreta average daily design volume:

- Estimate the SPM equivalent combined sewage DDF following the SPM.
- Estimate the average excreta daily volume following the standards of this Section. For sites with intermittent or fluctuating usage use the projected average daily volume for the peak use week.

For residential use sites, estimate the average excreta daily volume using the values in Table B- 1 for SPM equivalent occupancy.

Table B- 1. Adopted parameters for residential excreta

PARAMETER	FECES, PER DAY PER CAPITA	URINE, PER DAY PER CAPITA
Wet mass (g)	180	1500
Dry mass (g)	50	60
Volume (L)	0.18	1.5

Note: For micro flush toilets or water-borne systems with separation, estimate the added volume of leachate or water separated from blackwater.

For public user sites, estimate the average excreta daily volume using the values in Table B- 2.

Table B- 2. Adopted parameters for public use site excreta

PARAMETER	FECES, PER EVENT	URINE, PER EVENT
Wet mass (g)	180	215
Volume (L)	0.18	0.2

Note: For micro flush toilets or water-borne systems with separation, estimate the added volume of leachate or water separated from blackwater.

B- 1.5 System selection standards

Select a composting toilet and process that is suitable for the building and use, to meet the primary objectives. The system and process may be any one of the following:

- A proprietary unit, or
- A site built unit constructed following standard practice for an open source system, or
- A system custom designed by a professional.

Select and specify the composting toilet system to reliably produce residual organic matter meeting the secondary objectives established for the system.

B- 1.6 Specification and Installation standards

This section sets the standards for specifying and installing composting toilet systems.

Collection systems or processors that discharge leachate onto the surface of the ground, or into the surrounding soil are **not allowed**.

Hygiene standards of Table B- 3 apply to all components of the composting toilet system.

Table B- 3. Composting toilets general specification and installation standards

Pedestal	<ul style="list-style-type: none"> ○ Use only non-absorbent, durable, non-corrodible, waterproof materials that allow regular cleaning ○ To be safe for use ○ Sealed to meet venting and vector access standards of this table
Collection system	<ul style="list-style-type: none"> ○ Ensure environment is not contaminated during transport of materials ○ Ensure collection container will be manageable by hand, or specify mechanical handling equipment to allow safe handling ○ Provide method for cleaning of collection system or conveyance containers with discharge of contaminated water to compost or to a sewerage system ○ Specify the collection system to avoid unplanned retention of excreta in or on system components
Temperature and moisture	<ul style="list-style-type: none"> ○ If heating is needed to allow the processor to reach specified process temperatures, ensure adequate heating and insulation is provided. ○ Provide access or install probes to monitor temperature of the outer parts of the material undergoing processing ○ Provide access to allow monitoring of moisture content ○ Specify a way to adjust moisture content
Venting	<ul style="list-style-type: none"> ○ For pedestal and collection system venting, and for in building processors, vent above roof line to meet the BC Building Code standards for chimneys ○ Use stainless steel insect screening ○ Check that vent system and sealing of system components controls odors ○ Ensure that vent system does not discharge air into the building interior ○ Provide adequate ventilation to maintain aerobic conditions in processor ○ Use smoke to test the ventilation system during commissioning

Vector access	<ul style="list-style-type: none"> ○ Prevent vector access to waste ○ Seal components to prevent insect or rodent access and egress ○ For toilet buildings, insect screen building openings ○ Specify a sealing pedestal lid or ventilation system to reduce insect access
Hygiene	<ul style="list-style-type: none"> ○ Use non-absorbent, durable, non-corrodible, waterproof materials that allow regular cleaning and sanitizing. ○ Prevent unauthorized access to conveyance piping or container ○ Prevent accidental contact with human waste by user, whether sitting or standing ○ Provide means for hand hygiene ○ Identify and label any containers or tools used for collection system or processor ○ Ensure access for removal of residual organic matter is planned to prevent contamination of living areas or other unauthorized contact with human waste by occupants or users ○ Ensure waste and residual organic matter is contained at all times
In unit composting processor	<ul style="list-style-type: none"> ○ Use non-absorbent, durable, non-corrodible, waterproof materials that allow regular cleaning ○ Sealed to prevent exfiltration or infiltration of odours or liquids (including groundwater and leachate)
Maintenance and monitoring access	<ul style="list-style-type: none"> ○ Provide adequate and safe access for maintenance and monitoring ○ Provide for access to allow safe replacement of any mechanical and electrical components ○ Prevent unauthorized access to human waste ○ Provide signage specifying proper operation and maintenance procedures
Bulking agents and additives	<ul style="list-style-type: none"> ○ Specified to meet process requirements ○ Dedicated container or addition system
Leachate management	<ul style="list-style-type: none"> ○ Provide for management of leachate ○ Provide adequate drainage to avoid saturation of material by leachate ○ Base and sides of processor to be watertight to above maximum possible leachate level ○ Discharge leachate (through sanitary drainage system to BC Plumbing Code for buildings with a water supply) to sewerage system or sewer
Horizontal separation	<ul style="list-style-type: none"> ○ When using a separate processor that is based on or below grade, provide a horizontal separation that meets the SPM standards for watertight treatment or pump tank

Installation	<ul style="list-style-type: none"> ○ Follow manufacturer guidelines or open source guidelines for the unit ○ Meet BC Building and Plumbing Code and BC Electrical Code (except for approved alternative solutions) ○ Check that any structural components meet the BC Building Code ○ Electrical components must comply with the BC Electrical Code
Trash receptacle and signage	<ul style="list-style-type: none"> ○ Available trash receptacle, in close proximity to the toilet pedestal ○ For public use sites, permanent, prominent, signage posted instructing users to place trash in the receptacle, not the toilet

Table B- 4. Dry toilets

General	<ul style="list-style-type: none"> ○ Follow the standards of Table B- 3.
Urine diversion	<ul style="list-style-type: none"> ○ Divert urine using either urinals or a urine diverting toilet pedestal
Toilet paper (if diverted)	<ul style="list-style-type: none"> ○ Provide sanitary container to collect toilet paper ○ Container to prevent vector access to the collected material ○ Safely dispose of toilet paper, or incinerate the paper ○ Incineration to meet standards for incinerating toilets, Table B- 8

Table B- 5. Toilets with separate composting processor

General	<ul style="list-style-type: none"> ○ Follow standards of Table B- 3 ○ Provide for labeling of batches to identify time of last addition of fresh material ○ Label collection containers as biohazard
Open container or bin compost processor	<ul style="list-style-type: none"> ○ Not allowed in a closed building ○ Enclose in a fenced area ○ Allow minimum 1.2 m clearance from fence to processor on all sides, or 1.2 m minimum clearance on at least one side if provided with walls on other sides ○ Secured to prevent unauthorized access and access by rodents and other larger vectors (including pets) ○ Minimum capacity to allow up to 2 year cycle ○ Base on impervious surface with drain to leachate collection and discharge system ○ Protected by land shaping or drainage to prevent run on of surface water or run off of leachate
Closed container processor	<ul style="list-style-type: none"> ○ Meet the standards for open container processor, except for fencing. ○ Base and sides of processor to be watertight to above maximum possible leachate level ○ Use only non-absorbent, durable, non-corrodible, waterproof materials that allow regular cleaning and sanitizing.
Leachate management	<ul style="list-style-type: none"> ○ Follow standards of Table B- 3
Size and number of processors	<ul style="list-style-type: none"> ○ Size the processor to allow each batch to go through all steps specified for the system. ○ Use at least two processors ○ Provide space to allow addition of up to 2 times the specified number of processors

Table B- 6. Incinerating toilets

General standards	<ul style="list-style-type: none"> ○ Follow applicable standards of Table B- 3
Climate	<ul style="list-style-type: none"> ○ Ensure incineration process can reach operating temperatures in coldest weather conditions for site and at maximum loading

Table B- 7. Hand hygiene system for composting toilets or urinals installed with no water supply

Hand sanitizer dispenser	<ul style="list-style-type: none"> ○ Installed to meet manufacturer standards ○ A minimum of 15 cm from any light switch or electrical outlet ○ Do not install above carpeting or other covering where accumulated sanitizer could lead to a fire hazard ○ Meet local fire prevention standards ○ With signage showing how to properly use the sanitizer
Sanitizer	<ul style="list-style-type: none"> ○ Liquid, spray, gel or foam ○ Tested too meet or exceed minimum performance objectives in Section D- 1.3.4 ○ Disallow the use of wipes or towelettes

B- 1.7 Residual organic matter processing standards

See Section B- 1.9, Page 40, for hygiene standards for handling of excreta and residual organic matter during processing.

B- 1.7.1 INCINERATION

Table B- 8. Incineration

Process	<ul style="list-style-type: none"> ○ Complete incineration, with all parts of the waste burned to ash ○ Follow manufacturer guidelines, including addition of any required anti-foaming agents and masking foam
Residual material after incineration, for on-site discharge	<ul style="list-style-type: none"> ○ Test to confirm maximum total carbon content <10% wt./dry wt. or maximum volatile solids <18% wt./dry wt. ○ Test per batch at least once prior to on-site discharge ○ AP to review and summarize test results prior to discharge
Documentation	<ul style="list-style-type: none"> ○ The owner to retain test results (above)
Discharge method, for residual material meeting incinerated material standards	<p>Material may be either:</p> <ul style="list-style-type: none"> ○ Discharged off-site to an approved facility, or ○ Discharged on-site (see Section B- 1.8.3)
Discharge method, for residual material not meeting incinerated material standards	<p>Material may be either:</p> <ul style="list-style-type: none"> ○ Discharged off-site to an approved facility, or ○ Returned to the incinerator for further incineration

B- 1.7.2 CURING**Table B- 9. Curing**

Conditions and installation	<ul style="list-style-type: none"> ○ Maintain aerobic conditions at the specified moisture content ○ Use a batch process only ○ Protect the processor from rainfall ○ Collect all leachate
Installation	<ul style="list-style-type: none"> ○ Specify and install the processor to meet the standards of Section B- 1.6 ○ Provide a method for monitoring, including of temperature and moisture.
Holding time	<ul style="list-style-type: none"> ○ Minimum 18 months if temperature of organic matter is maintained above 5 C ○ Minimum 24 months if temperature of organic matter falls for more than 7 days at a time below 5 C
Holding time after initial thermophilic step	<ul style="list-style-type: none"> ○ After a thermophilic stage documented to meet the standards of Table B- 10 ○ Minimum 12 months if temperature of organic matter is maintained above 5 C ○ Minimum 18 months if temperature of organic matter falls for more than 7 days at a time below 5 C
Monitoring	<ul style="list-style-type: none"> ○ Temperature monitoring, at minimum weekly during times of the year where ambient temperatures drop below 5C at any time. ○ Temperature monitored near the edge of the pile or container ○ Confirm that the process is maintaining aerobic conditions ○ Confirm that moisture content is in the range of 40 to 70% (by observation), weekly
Documentation	<ul style="list-style-type: none"> ○ Documentation of time, temperature and moisture content ○ The owner to retains records of the monitoring ○ The AP reviews monitoring records for the batch prior to on-site discharge

B- 1.7.3 ON-SITE SANITIZING OR DISINFECTION**Table B- 10. Time at temperature**

For thermophilic step	<ul style="list-style-type: none"> ○ For aerobic process, provide a minimum of 3 days at higher than 55 C throughout the insulated pile or container ○ For a mixed anaerobic process, provide a minimum of 1 day at higher than 55 C without interruption, and minimum of 20 days dwell time in the reactor ○ Followed this with a curing step that complies with the standards of B- 1.7.2
For pasteurization step	<ul style="list-style-type: none"> ○ Provide a minimum 1 hour pasteurization at a minimum 70 C temperature, in an insulated vessel
Temperature testing	<ul style="list-style-type: none"> ○ For open container systems, measure the temperature at a minimum of 6 locations at the periphery of the pile or container, record the lowest temperature reading ○ Measure and record temperatures at minimum daily
Monitoring	<ul style="list-style-type: none"> ○ For thermophilic aerobic systems, by owner with review by AP ○ For pasteurization or anaerobic process thermophilic step, monitoring to be by or under the supervision of an AP
Documentation	<ul style="list-style-type: none"> ○ Record of time at temperature ○ The owner retains records of monitoring ○ The AP reviews monitoring records for the batch prior to on-site discharge

Table B- 11. pH adjustment using lime or ash

For treatment prior to on-site surface discharge	<ul style="list-style-type: none"> ○ Maintain pH within the solids at or above 12, for a minimum of 72 hours ○ With a minimum period of 12 hours of this time at a temperature over 52 C ○ After treatment, air dry to moisture content of less than 50%,
For treatment prior to on-site burial	<ul style="list-style-type: none"> ○ Use a batch process only ○ Use only with stabilized organic matter, either tested following CAN/BNQ standards and meeting CCME guidelines for maturity/stability or with a Solvita stability (CO₂) index of 5 or greater and a moisture content of 75% or less ○ When using ash, add a minimum of 1 part ash to 3 parts of residual organic matter ○ When using hydrated lime, add a minimum of 30 g hydrated lime to 1 kg residual organic matter ○ After lime or ash is added, mix thoroughly ○ Test pH ○ Add additional lime or ash to increase pH if necessary ○ Cure for a minimum of 120 days at pH>10 or 180 days at pH>9, following the standards of B- 1.7.2 ○ Do not allow leaching or dilution (including by rainfall)
Documentation	<ul style="list-style-type: none"> ○ Documentation of time, quantity of chemical(s) added, testing results. ○ The owner retains records of monitoring ○ The AP reviews monitoring records for the batch prior to on-site discharge

Table B- 12. Urea and ammonia sanitizing

For treatment prior to on-site discharge	<ul style="list-style-type: none"> ○ Apply urea only to stabilized organic matter, either tested following CAN/BNQ standards and meeting CCME guidelines for maturity/stability, or with a Solvita stability (CO₂) index of 5 or higher, and ○ Maintain the temperature of material during treatment at 20 C or higher
Process	<ul style="list-style-type: none"> ○ Use a batch process only ○ Apply urea only when the moisture content of the material is 75% or less prior to treatment ○ Add urea at a ratio of 2% by weight to moist weight of residual organic matter (20 g of urea granules or pills per kg or moist residual organic matter) ○ Mix thoroughly and allow the mixture to stand for 60 days in a closed container ○ Test the ammonia level, meet a Solvita (ammonia), index of 1 (high ammonia) after 7 days or meet total ammonia N (ppm dry basis) of >20,000 at pH 8.0, >7000 at pH 8.5 or >4000 at pH 9.0. ○ If ammonia level does not meet standard, apply a further 1% urea by weight and re test after 7 days.
Documentation	<ul style="list-style-type: none"> ○ Documentation of time, temperature, quantity of urea added, testing results. ○ The owner retains records of monitoring ○ The AP reviews monitoring records for the batch prior to on-site discharge

B- 1.8 Discharge standards for residual organic matter

B- 1.8.1 STORAGE OF RESIDUAL ORGANIC MATTER

Table B- 13. Storage of residual organic matter

Storage of residual organic matter	<ul style="list-style-type: none"> ○ Plan, construct and manage storage to prevent escape of organic matter or leachate to the environment ○ Cover the residual organic matter, if necessary, to avoid leaching by rainfall
Minimum horizontal separation for storage location (closed container)	<ul style="list-style-type: none"> ○ Follow standards for composting processors, Table B- 3
Minimum horizontal separation for storage location (open storage)	<ul style="list-style-type: none"> ○ 15 m to fresh water or sea water ○ 30 m to a source of drinking water or drinking water supply well ○ 15 m to a property line

B- 1.8.2 OFF-SITE DISCHARGE

If planning for off-site discharge, specify and install the composting toilet processor to allow safe and hygienic removal of accumulated organic matter. Identify an approved discharge facility prior to filing.

B- 1.8.3 ON-SITE DISCHARGE

B- 1.8.3.1 On-site surface discharge

If planning for on-site surface discharge of composting toilet residual organic matter from small residential system with SPM equivalent DDF for 2400 L/day or less, then:

- A professional must supervise the discharge; and
- The discharge must comply with the requirements of the *Environmental Management Act*

B- 1.8.3.2 Standards for on-site burial

If planning on-site burial of composting toilet residual organic matter, and if the SPM equivalent combined sewage DDF is 9100 L/day or less (a "small system"), then, follow the small system standards in Table B- 14 and Table B- 15.

For an SPM equivalent combined sewage DDF greater than 9100 L/day require a site and project specific custom design for on-site burial, with filing by a professional.

Follow the standards of Section B- 1.9.1, page 40, when handling residual organic matter.

Table B- 14. Residual organic matter quality for small systems with on-site burial

Minimum quality	<ul style="list-style-type: none"> o No recognizable fecal material o Maximum 75% w/w moisture (assessed by testing or estimation) o No sharp foreign matter o Less than one piece of foreign matter greater than 25 mm in any dimension per 500 mL
Minimum stability and maturity for all processes except incineration, using analytical test methods	<ul style="list-style-type: none"> o Test at least one sample from the center of the batch o Test the material following CAN/BNQ standards to meet CCME guidelines for maturity/stability o Except for residual organic matter sanitized using the urea method (Table B- 12), test ammonia content, total ammonia N of <500 ppm (dry basis).
Minimum stability and maturity for all processes except incineration, using the Solvita test method	<ul style="list-style-type: none"> o Test the material and confirm an Ammonia and CO₂ combined Solvita maturity index of 5 to 8; or, o For residual organic matter sanitized using the urea method (Table B- 12) a CO₂ Solvita stability index of 5 or greater o Collect and test at least one sample from centre of batch
Type of process	<ul style="list-style-type: none"> o Batch curing step meeting the standards of Section B- 1.7 o And, or batch sanitizing step meeting the standards of Section B- 1.7 o Or incineration step
Monitoring of process and batch	<ul style="list-style-type: none"> o Meet the standards of Section B- 1.7.
Minimum process and quality for residual mulch	<p>Mulch media (see Section Table B- 25) may be buried on site if:</p> <ul style="list-style-type: none"> o The mulch media is from a mulch basin system meeting the standards of this Manual, or is cover mulch from a chamber system; and o The material meets the minimum quality standards of row 1 of this table

Table B- 15. On-site burial of residual organic matter for small systems

Plan for on-site burial	<p>Prepare a plan for on-site burial that:</p> <ul style="list-style-type: none"> ○ Forms part of the sewerage system filing; ○ Includes site and soil evaluation and drawings that meet SPM standards; and ○ Specifies monitoring for each batch of residual organic matter to meet the standards of Table B- 14, prior to on-site burial.
Implementation of on-site burial	<p>Residual organic matter may be buried if:</p> <ul style="list-style-type: none"> ○ Buried in June, July or August; ○ Burial is supervised by an Authorized Person; and ○ The AP provides a written report to the owner.
Storage of residual organic matter	<ul style="list-style-type: none"> ○ Plan, construct and manage storage to prevent escape of organic matter or leachate to the environment ○ Cover the residual organic matter, if necessary, to avoid leaching by rainfall
Minimum horizontal separation for storage location	<ul style="list-style-type: none"> ○ 15 m to fresh water or sea water ○ 30 m to a source of drinking water or drinking water supply well ○ 15 m to a property line
Minimum horizontal separation for burial location	<ul style="list-style-type: none"> ○ 30 m to a source of drinking water or drinking water supply well ○ 30 m to fresh water, seasonal fresh water, or sea water ○ 15 m to breakout (as defined in the SPM) ○ 3 m to a property line ○ Other setbacks to follow the SPM horizontal separations for dispersal areas
Soil type for burial	<ul style="list-style-type: none"> ○ Bury material in a native soil of permeability, texture, structure and consistence that would allow for gravity distribution under the SPM
Minimum soil vertical separation below buried material	<ul style="list-style-type: none"> ○ Meet the SPM standards for gravity dispersal at a Type 2 hydraulic loading rate, for the soil type and permeability of the soil at the burial site.
Cover soil	<p>Cover the residual organic matter with soil that meets the following:</p> <ul style="list-style-type: none"> ○ Soil depth 15 cm to 30 cm. ○ Soil texture group the same as the native soil, or Loamy Fine Sand, Loamy Sand or Sandy Loam. ○ Grassed or otherwise vegetated
Minimum allowable burial area	<ul style="list-style-type: none"> ○ Select soil loading rate following the SPM standards for a Type 2 HLR ○ The maximum allowable residuals loading rate in kg/m² is equal to the Type 2 HLR (L/day/m²) multiplied by a factor of 3.5 ○ The minimum allowable burial area is equal to the moist mass of residual organic matter (kg) divided by the residuals loading rate
Minimum contour length of the burial area	<ul style="list-style-type: none"> ○ 3 m for SPM equivalent DDF of up to 2400 L/day ○ 7.5 m for SPM equivalent DDF of up to 9100 L/day
No disturbance of area	<ul style="list-style-type: none"> ○ Mark burial location with labelled stakes ○ Do not disturb the buried material for at least 2 years after burial.
Reserve area	<ul style="list-style-type: none"> ○ Set aside land for burying residual organic matter over a period of 30 years without using the same burial location more than once. ○ Provide at least 3 m separation between burial trenches or beds.

B- 1.9 Maintenance standards

B- 1.9.1 HEALTH AND HYGIENE DURING HANDLING

Assume all waste and all residual organic matter is hazardous and treat with caution.

When handling waste or residual organic matter reduce risk:

- Of inhalation; wear a face mask.
- Of contact; wear protective clothing, including thick waterproof gloves (covering wrists to jacket or overalls) and goggles.
- Of contact; wash and disinfect handling equipment, protective clothing and gloves after use, or mark, segregate and label any handling equipment or personal protective equipment that is not disinfected and store in a low humidity restricted access area with protection from vector access.
- Of ingestion; restrict access to residual organic matter, and particularly restrict access by children.
- From vector transmission; restrict access by vectors including rodents, flies and arthropods
- From leachate; properly discharge leachate to a sewerage system and prevent rainfall leaching.

B- 1.9.2 PROCESSING OF RESIDUAL ORGANIC MATTER

When reviewing and summarizing monitoring records, provide a report to the owner.

B- 1.9.3 MAINTENANCE

Include in the maintenance plan:

- Specified outcomes, based on the primary purposes and any defined secondary purposes and objectives.
- A description of the specified process together with all monitoring required to achieve the specified outcomes.
- Instructions on what to do if the specified outcomes are not met.
- Schedule of maintenance and monitoring.
- Discharge procedures for residual organic matter meeting the applicable standards of Section B- 1.8.
- A timetable for regular review of the plan and the maintenance and monitoring records by the planner or other equally qualified AP.
- Stamp and signature of the Authorized Person that prepared the plan.

The maintenance plan may be integrated with the maintenance plan for the source separated wastewater system.

Table B- 16 specifies standards for maintenance plans and maintenance of the system.

Table B- 16. Maintenance and monitoring standards

Instructions for owner in the maintenance plan	<ul style="list-style-type: none"> ○ Instructions for toilet users ○ Instructions for operation and management of the system ○ Performance objectives for the system ○ Dos and don'ts and source control policy ○ Actions to be taken in an emergency and troubleshooting procedures
Additives	<ul style="list-style-type: none"> ○ Specify any additives, bulking agents and cover materials to be used in the collection system and processor ○ Specify quantity of additive to be used, where appropriate
Lime or ash addition to dry toilets	<ul style="list-style-type: none"> ○ Do not add lime or ash if residual organic material is destined for composting
Monitoring and management of process (for any system with on-site discharge)	<ul style="list-style-type: none"> ○ Specify monitoring of the process by operator (owner) including a minimum recording interval ○ Describe the monitoring, and how to maintain the composting process, for all stages of the process ○ Specify how the owner or operator will record this information ○ Record amendments and alterations made to maintain the composting process
Off-site discharge	<ul style="list-style-type: none"> ○ Identify which options or sites that the AP has pre-approved. ○ Recommend safe practices for discharge.
Precautions during maintenance	<ul style="list-style-type: none"> ○ Specify precautions for anybody that may enter a confined space that may contain hazardous gases, e.g. if ventilation has malfunctioned. ○ Meet, at minimum, standards of Section B- 1.9.1 when handling residual organic matter
Maintenance and monitoring, on-site burial location	<ul style="list-style-type: none"> ○ Specify monitoring of the cover, reserve area and staking for the burial location, following the standards of Section B- 1.8.3 ○ Specify procedures for batch burial.
Planting of burial area	<ul style="list-style-type: none"> ○ Specify perennial plantings only ○ Do not plant with soft stemmed food crops

B- 2 SOURCE SEPARATED WASTEWATER SYSTEM STANDARDS

B- 2.1 Introduction

Section B- 2 contains this Manual's standards of practice for the application of source separated wastewater systems in BC.

See the Appendix Part D for the performance basis of these standards. See the Appendix D- 2 for design manuals.

B- 2.2 Procedure standards

B- 2.2.1 DOCUMENTATION AND GENERAL STANDARDS

- Document the calculations and design rationale and include a summary with the filing documentation.
- Follow the SPM standards for sewerage systems, except as otherwise specified in this Manual.

B- 2.2.2 SOURCE CHARACTERIZATION AND DESIGN FLOWS

- Characterize the wastewater source and building use. Identify which sources are to be separated.
- Estimate the SPM equivalent combined sewage Daily Design Flow (DDF) based on the SPM standards, and adjust this to daily design flows for individual source separated wastewater streams (following Section B- 2.3).

B- 2.2.3 SOURCE SEPARATED WASTEWATER SYSTEMS FOR SEASONAL IRRIGATION

- Site and soil evaluation:
 - Asses the depth of soil to the limiting layer based on evaluation of the soil profile during the irrigation season
 - Assess horizontal separation based on evaluation during the irrigation season
- Selecting a suitable system based on site conditions:
 - Consider the plants to be irrigated and the soil type
 - Write the rationale for the irrigation system
- Identify in the filing the alternative discharge method to be used when wastewater is not being diverted

B- 2.2.4 FILING

- File the source separated wastewater system with the regional Health Authority, under the SSR.
- Include information on any existing system used to accept human excreta or other wastewater flows from the site.

B- 2.2.5 MAINTENANCE PLANS

In the maintenance plan include:

- Source control information for the owner specific to the wastewater stream
- Information on planting and irrigation scheduling, where relevant

B- 2.3 Design flow standards

B- 2.3.1 RESIDENTIAL DAILY DESIGN FLOWS

Select the daily design flow for a source separated wastewater stream as follows:

- Select the SPM equivalent DDF for a combined sewage system following SPM section II-5 standards
- Select an adjustment factor from Table B- 17 for the specific wastewater stream
- Multiply the selected SPM equivalent combined sewage DDF by this adjustment factor to obtain the daily design flow for the source separated wastewater stream.

Table B- 17. Residential Daily design flow adjustment factors

SOURCE SEPARATED STREAM	ADJUSTMENT FACTOR
Combined sewage	1
Urine	0.0085
Leachate (without flush or wash down water)	0.0085
Blackwater or brownwater	0.33
Water separated from blackwater (includes water separated from brownwater)	0.33
Combined greywater	0.70
Dark greywater	0.07
Light greywater	0.65
Laundry greywater	0.35

Notes:

- Adjusted flows include a peaking factor of 2, as is the case for SPM DDF.
- Where a garburator is used, increase the combined greywater daily design flow by a factor of 2 and increase the dark greywater daily design flow by a factor of 2, for the purpose of sizing the dispersal system. Do not double the flow reported on the Record of Sewerage System form.
- Add flush or wash down or urinal flush water to leachate or urine volume. Add 2 x the estimated average daily volume of flush or wash down water.

B- 2.3.2 NON-RESIDENTIAL DAILY DESIGN FLOWS

For sites where urine diversion and or hand washing facilities are co-located with composting toilet(s), estimate number of uses per day for the facility and use the following minimum daily design flows (including the daily design flow peaking factor of 2):

- For diverted urine, use a rate of 0.43 L/use (plus 2 x the average per use volume of any added flush water)
- For leachate, use a rate of 0.3 L/use (plus 2 x the average per use volume of any added flush water)
- For hand basins (light greywater), use a rate of 7 L/use

Select design flows for other non-residential source separated wastewater by either:

- Using the SPM equivalent combined sewage DDF for the building and use, without adjustment, or
- Engage a qualified professional to select the design flow.

B- 2.4 Collection and treatment standards

Table B- 18. Urine collection and storage systems

Collection system, piped	<ul style="list-style-type: none"> ○ Comply with the BC Plumbing Code (up to the first storage tank located outside house or the first dispersal system component) ○ Do not use metal components ○ Use a minimum 2" nominal pipe size ○ Use cleanouts that meet the BC Plumbing Code
Collection for storage	<ul style="list-style-type: none"> ○ Do not dilute urine prior to storage
Waterless urinals	<ul style="list-style-type: none"> ○ Install odor traps to manufacturer standards and to meet the BC Plumbing Code
Urine collection containers	<ul style="list-style-type: none"> ○ Watertight and airtight plastic or fiberglass containers ○ Labeled to identify as non-potable water and to identify risk of pathogens ○ Provide access for cleaning
Discharge to storage container or tank	<ul style="list-style-type: none"> ○ Extend collection pipe to near base of container or tank
Collection system, discharge funnel or sink	<ul style="list-style-type: none"> ○ Clearly labeled ○ Ensure drains fully between doses ○ With odor trap and vent if connected to a septic tank ○ With odor trap if discharging to storage ○ Extend collection pipe to base of storage container if discharging to storage ○ Cover or provide an insect screen to deter vector access
Urine storage systems for seasonal dispersal	<ul style="list-style-type: none"> ○ Size the urine storage system for a minimum 3 month storage for urine at a temperature of 10 to 20 C prior to dispersal ○ Use at least two storage containers to allow separation of urine batches ○ For systems that serve a non-residential use or that have an SPM equivalent combined sewage DDF of more than 2400 L/day, specify urine storage for a minimum 6 months at a temperature of 10 to 20 C
Urine storage containers or tanks	<ul style="list-style-type: none"> ○ Use watertight and airtight plastic or fiberglass containers ○ Specify pressure equalization for tank (unless a bladder tank is specified) ○ Structurally sound and appropriate for the installation location ○ Provide access for mixing and cleaning, with riser to grade if sub surface ○ Specify a method to allow date labeling
Fresh water dilution of urine	<ul style="list-style-type: none"> ○ Protect potable water from cross contamination protection in compliance with the BC Plumbing Code

Table B- 19. Leachate collection systems

Collection system, piped	<ul style="list-style-type: none"> ○ Comply with the BC Plumbing Code (up to first septic tank) ○ Do not use metal components
Collection system, pumped	<ul style="list-style-type: none"> ○ Comply with the BC Plumbing Code ○ Provide a high level alarm
Collection system, container	<ul style="list-style-type: none"> ○ Use watertight and airtight plastic or fiberglass containers ○ Structurally sound and appropriate for the installation location ○ Labeled to identify as non-potable water and to identify risk of pathogens ○ Provide access for cleaning
Collection system, discharge funnel or sink	<ul style="list-style-type: none"> ○ Label as non-potable water and to identify risk of pathogens ○ Ensure drains full between doses ○ Provide a trap and vent if the system is connected to a septic tank ○ Cover or provide an insect screen to deter vector access

Table B- 20. Greywater diversion collection system

General	<ul style="list-style-type: none"> ○ Ensure plumbing complies with the BC Plumbing Code (up to first septic tank or first dispersal system component)
Diversion valving	<ul style="list-style-type: none"> ○ Use manual valves or automated valves with manual override ○ Use valves that are resistant to contamination and corrosion ○ Provide access to valves for operation and maintenance, provide for valves to be cleaned and serviced in place or installed to allow easy removal for cleaning ○ Label each valve to show the source and destination of flows ○ Use a valve of the same size as the sanitary drainage piping ○ Install valves downstream of plumbing traps, ensure venting regardless of valve position
Pumped systems	<ul style="list-style-type: none"> ○ Comply with BC Plumbing Code (if before first tank or dispersal component location) ○ Use a high level alarm
Filtration systems	<ul style="list-style-type: none"> ○ Do not use a non-pressurized filter that retains water in the filter or basin
Surge tanks	<ul style="list-style-type: none"> ○ Use watertight tanks, with vents that comply with the BC Plumbing Code ○ Provide access for cleaning and maintenance ○ Provide with an overflow to either a public sewer, a sewerage system or an all season source separated wastewater system ○ Label each surge tank

Table B- 21. Septic tank minimum working volumes and treatment systems

Combined sewage systems with seasonal diversion of wastewater(s)	<ul style="list-style-type: none"> ○ Size the combined sewage septic tank following the SPM ○ Size seasonal system tank(s) following standards of this Manual
Blackwater or brownwater septic tank	<ul style="list-style-type: none"> ○ 0.8 x the size of an SPM standard tank, based on the building and use
Septic tank for water separated from blackwater	<ul style="list-style-type: none"> ○ 3 x daily design flow for the wastewater stream ○ Minimum tank working volume 1000 L
Blackwater or brownwater plus dark greywater septic tank	<ul style="list-style-type: none"> ○ 0.9 x the size of an SPM standard tank, based on the building and use ○ Increase size by a factor of 1.5 if a garburator is used
Leachate septic tank	<ul style="list-style-type: none"> ○ 0.2 x the size of an SPM standard tank, based on the building and use ○ Minimum tank working volume 400 L
Dark greywater septic tank	<ul style="list-style-type: none"> ○ 0.2 x the size of an SPM standard tank, based on the building and use ○ Minimum tank working volume 400 L ○ Increase minimum working volume by a factor of 3 if a garburator is used ○ Or professional design to achieve performance objective of median 15 mg/L Oil and Grease in septic tank effluent
Light, laundry or combined greywater septic tank (seasonal or all season)	<ul style="list-style-type: none"> ○ 0.4 x the size of an SPM standard tank, based on the building and use ○ Minimum tank working volume 800 L ○ For a combined greywater tank, increase minimum working volume by a factor of 2 if a garburator is used
Light, laundry or combined greywater tank with urine or leachate added.	<ul style="list-style-type: none"> ○ 0.4 x the size of an SPM standard tank, based on the building and use ○ Minimum tank working volume 800 L ○ Add 2 x the urine or leachate daily design flow including flush or wash water flows to the minimum tank working volume ○ For a combined greywater tank, increase minimum working volume by a factor of 2 if a garburator is used
Type 2 and 3 treatment methods	<ul style="list-style-type: none"> ○ Follow SPM standards ○ Select the treatment system to achieve Type 2 or 3 performance standards based on the characteristics of the specific wastewater stream

Table B- 22. Septic tanks

General	<ul style="list-style-type: none"> ○ Follow the standards of the SPM except where varied by standards of this Manual
Minimum length inlet to outlet	<ul style="list-style-type: none"> ○ 90 cm measured from centerline of inlet tee to centerline of effluent filter

B- 2.5 Effluent dispersal standards

B- 2.5.1 HYDRAULIC LOADING RATES

B- 2.5.1.1 Hydraulic loading rates for native soil or sand media

Source separated wastewater may be discharged to native soil or sand media provided that:

- The discharge method complies with the SPM or the standards of this Manual
- The hydraulic loading rate does not exceed the rate specified below

Select the soil or sand media hydraulic loading rate (HLR) for native soil or sand media as follows:

- Select the soil or sand media maximum HLR for Type 1 effluent following SPM section II-5.5 standards
- Select an adjustment factor from Table B- 23 for the specific wastewater effluent stream
- Multiply the selected SPM HLR by this adjustment factor to obtain the maximum HLR for the source separated wastewater effluent.

Table B- 23. HLR adjustment factors

TYPE OF SOURCE SEPARATED WASTEWATER EFFLUENT	ADJUSTMENT FACTOR	OTHER REQUIREMENTS
Type 1 effluent	1	
Urine, diluted 1:10 with fresh water	0.7	Septic tank treatment not necessary
Leachate	0.7	
Blackwater, brownwater or blackwater/brownwater combined with dark greywater	1	
Water separated from blackwater, alone or combined with greywater	1	
Combined greywater	1	
Combined greywater combined with urine and or leachate	0.75	
Dark greywater	0.45	
Light greywater	1.5	
Light greywater combined with urine	1.2	If combined with leachate, use HLR as for combined greywater combined with leachate
Light greywater, no septic tank treatment	1.5	For a mulch basin system meeting Section B- 2.5.2.1 only
Light greywater combined with urine, no septic tank treatment	1.2	For a mulch basin system meeting Section B- 2.5.2.1 only

Notes:

- Dilute urine minimum 10 parts water or greywater to 1 part urine prior to dispersal.
- For laundry greywater use light greywater adjustment factors.

- These factors are for use only with daily design flows selected following the standards of this Manual.
- For mulch basin system HLR, see Section B- 2.5.2.2

Calculate the minimum required area of infiltrative surface (AIS) following SPM standard procedure.

B- 2.5.1.2 Hydraulic loading rates for Type 2 or 3 effluent

For source separated wastewater treated to meet Type 2 or 3 standards, use the source separated wastewater daily design flow established following Section B- 2.3. Apply the standards of the SPM for dispersal system planning, specification, installation, operation and maintenance for the specified effluent type.

B- 2.5.2 MULCH BASIN SYSTEMS

B- 2.5.2.1 Allowed discharge to mulch basins

Source separated wastewater may be discharged to a mulch basin system provided that:

- The wastewater source is residential;
- Discharge includes only light greywater, light greywater mixed with urine or urine diluted with fresh water;
- The SPM equivalent combined sewage DDF is 2400 L/day or less **or** the system is discharging only stored urine diluted with fresh water;
- Discharge is limited to the irrigation season; and
- The mulch basin system meets the standards of this Manual.

For these systems only:

- Septic tank pre-treatment is not needed; and
- The minimum contour length standards of the SPM do not apply.

B- 2.5.2.2 Hydraulic loading rates for mulch basin systems

For the mulch infiltrative surface, with media identified as "favorable" (Table B- 24, below), use a HLR of 450 L/day/m² or less. Select the native soil HLR for the basal area of the mulch basin following SPM Type 2 effluent HLR standards. Do not adjust native soil HLR.

For the mulch infiltrative surface, with media identified as "acceptable" (Table B- 24, below), use a HLR of 60 L/day/m² or less. Select the native soil HLR for the basal area of the mulch basin following SPM Type 1 effluent HLR standards, and adjust following Table B- 23 for the basal area soils.

B- 2.5.2.3 Basal area for mulch basin systems

Check the basal (native soil area of infiltrative surface) AIS meets standards:

- Divide the required basal area by the number of mulch basins.
- Lay out the mulch media infiltrative surface (chamber or infiltration enclosure) for the basin.
- Determine the effective basal area for each basin and check that the effective basal area meets or exceeds the required basal area for the basin.

The effective basal area for each basin is the area directly below the mulch infiltrative surface plus the surrounding mulch area within each basin, with the following limits:

- Up to a maximum total area of 10 times the mulch media infiltrative surface area per basin

- Only in the part of mulch basin with media depth (after settling) of 10 cm or greater below the mulch infiltrative surface

B- 2.5.2.4 Mulch basin systems distribution, dosing and vertical separation

Select the distribution and dosing options following the SPM standards for the site and soil. Select a dosing frequency based on the native soil.

Select the minimum vertical separation following the SPM standards, based on a Type 1 effluent HLR and considering the type of distribution and dosing specified.

The as-designed vertical separation is measured as the unsaturated vertical distance from the mulch infiltrative surface down to the limiting layer, during the irrigation season.

B- 2.5.2.5 Mulch basin systems horizontal separation

For a mulch basin, the horizontal separation distance is measured from the edge of the chamber or the infiltration enclosure.

B- 2.5.2.6 Mulch basin systems specification and installation

Table B- 24. Mulch basin systems

Distribution	<ul style="list-style-type: none"> ○ Specify distribution to basins by gravity, pressure or subsurface drip dispersal ○ For gravity distribution a branched drain system may be used ○ Where discharge is by dosing from an appliance pump ensure the discharge pipe provides an adequate air gap to prevent siphoning back to the appliance. ○ For dosed mulch basins ensure that surge capacity available in the mulch basin system is greater than the maximum dose volume, without saturating to the surface of the mulch.
Branched drain distribution	<ul style="list-style-type: none"> ○ Provide access ports with valve boxes for all splitters and reducing couplings. ○ Place flow splitters on a base of pea gravel or drain rock ○ Use reducing couplings to be readily disassembled for cleaning ○ Install the piping system to drain completely ○ Support the piping fully at a minimum 2% grade ○ Provide cleanouts on pipe runs longer than 15 m
Favorable media	<p>Bark, peat, coconut coir, bio-char, charcoal, artificial trickling filter media, provided that:</p> <ul style="list-style-type: none"> ○ Particle size effective diameter is between 2 and 20 mm ○ Less than 5% particles finer than 2 mm when installed ○ Saturated hydraulic conductivity (after settling) is at least 100 x higher than that of the basal area soils and is at least 1 cm/second.
Acceptable media	<ul style="list-style-type: none"> ○ Coarser bark, peat, coconut coir, bio-char, charcoal or artificial trickling filter media up to maximum 75 mm effective diameter; or ○ Compost (open graded with <10% passing the #200 sieve); or ○ Wood chips. <p>Provided that saturated hydraulic conductivity (after settling) is at least 10 x higher than that of the basal area soils.</p>
Infiltration system	<ul style="list-style-type: none"> ○ Use gravelless chamber or other vented enclosure ○ Constructed of plastic or other corrosion resistant material

Access to infiltrative surface	<ul style="list-style-type: none"> ○ Provide access for maintenance of the infiltrative surface and discharge piping ○ Install observation port(s) to allow visual inspection of the infiltrative surface ○ Seal access and inspection openings or insect screen to prevent vector access ○ Access ports to be labeled to identify greywater, sewage or bio-hazard
Media cover depth	<ul style="list-style-type: none"> ○ Provide at least 15 cm cover above infiltrative surface and above top of infiltration chamber or enclosure after settling ○ Specify that the minimum cover depth is to be maintained during system operation
Minimum media depth below infiltrative surface	<p>After settling and to be monitored and maintained during system operation, provide at least:</p> <ul style="list-style-type: none"> ○ 20 cm depth for favorable media ○ 30 cm depth for acceptable media
Monitoring provisions for media depth	<ul style="list-style-type: none"> ○ Install a permanent, marked stake or other means to allow observation of media depth
Basal area observation ports	<ul style="list-style-type: none"> ○ Install at least one port per mulch basin ○ Install ports following SPM standards for sand mounds

B- 2.5.3 ALL SEASON SYSTEMS AND SEASONAL SUB IRRIGATION SYSTEMS

Mulch may be used to cover chamber dispersal systems for all wastewater streams. Specify mulch cover to meet the minimum mulch selection and cover depth standards of Table B- 24.

B- 2.5.4 SUBSURFACE DISCHARGE AND COVER

Ensure all types of wastewater effluent will be discharged below the surface, and that adequate cover is provided over the infiltrative surface, dispersal system aggregate or chambers. Provide at least 15 cm cover above the top of dispersal system chambers or aggregate.

B- 2.6 Maintenance standards

Table B- 25. Mulch basin systems

General	<ul style="list-style-type: none"> ○ Meet minimum standards of the SPM for the maintenance plan and maintenance of the system ○ Maintain and monitor the system at least once a year ○ Add maintenance and monitoring steps to the maintenance plan to meet irrigation and fertigation objectives ○ At the end of the irrigation season, use the observation ports to check the condition of the mulch infiltrative surface
Branch drain system, annual maintenance	<ul style="list-style-type: none"> ○ Inspect all observation ports of the branch drain system ○ Test the flow and splitting of water through the branch drain system
Mulch basin media and cover mulch	<ul style="list-style-type: none"> ○ Specify monitoring of cover depth ○ Specify management and discharge method for any mulch and roots that are removed from the basin. ○ Monitor media depth and condition below infiltrative surface ○ Specify how to maintain or replace mulch media and cover ○ Follow health and hygiene standards of Section B- 1.9.1, page 40, when maintaining mulch systems
Management of mulch media	<p>For mulch from mulch basins meeting the standards of this Manual and for cover mulch from chamber systems:</p> <ul style="list-style-type: none"> ○ Discharge the mulch off-site to an approved facility; or ○ Bury the mulch on-site following the standards of Section B- 1.8.3.2; or ○ Convey the mulch to a composting toilet system processor and follow standards for composting toilet systems

Table B- 26. All season systems

General	<ul style="list-style-type: none"> ○ Meet standards of the SPM for the maintenance plan and maintenance of the system ○ In the maintenance plan, add maintenance and monitoring steps for any sub irrigation system
Mulch cover	<ul style="list-style-type: none"> ○ In the maintenance plan, include monitoring of the cover depth and specify procedures for maintenance or replacement of the cover ○ During maintenance, monitor the cover depth and condition and replace or top up as needed.

Part C Guidelines

C- 1 COMPOSTING TOILET SYSTEM GUIDELINES

C- 1.1 Introduction

See Section A- 5 on page 19 for an introduction to composting toilet systems. Refer to the Appendix D- 2 for design manuals and other resources.

C- 1.2 Procedure guidelines

See the Appendix D- 5 for guidance on filing documentation.

C- 1.2.1 FILING FORM

On the filing form:

- Identify a composting toilet system as a "Type 1" system
- Declare the system daily design flow following Section C- 1.2.2

If the filing does not include any wastewater discharge, and residual organic matter is planned to be discharged off-site, soils and discharge area horizontal separation information may be shown as "NA" (not applicable).

C- 1.2.2 FILING DESIGN FLOW AND SYSTEM TREATMENT CAPACITY

When making a filing the SSR requires a declaration of estimated "combined design daily domestic sewage flow".

Determine the value to declare in the filing as follows:

- For a filing which includes a composting toilet and associated source separated wastewater system, use the SPM equivalent combined sewage DDF.
- For a filing which is for a composting toilet system only, use the excreta average daily design volume (estimated following the standards of Section B- 1.4.2).

Record in the filing documentation the source and calculation of the declared flow and the maximum design capacity of the composting toilet system.

C- 1.2.3 DOCUMENTATION

Composting toilet systems and the composting process need ongoing documentation of monitoring and process data. This is particularly the case for systems with on-site discharge of residual organic matter.

To avoid this becoming onerous, and to avoid notes getting lost, a system log book is recommended. The log book should start with a summary of maintenance and monitoring objectives, procedures and schedules.

The book is then used to record operation, monitoring and maintenance of the system. Discharge of batches can be documented by recording in the log book. The AP can make a review of the log book prior to discharge of a batch.

C- 1.3 System purpose and objectives guidelines

C- 1.3.1 PRIMARY PURPOSES

The primary purposes of the composting toilet system are based on providing multi barrier management of health risk. Performance objectives of this Manual for the composting toilet system components are based on the objectives of the BC Building Code.

C- 1.3.2 SECONDARY PURPOSES

C- 1.3.2.1 Off-site discharge

In the case of off-site discharge, the composting toilet pedestal, collection system and processor fill a similar role to a water closet, sanitary drainage system and septic tank.

If applicable, select and specify the composting toilet system to meet volume and mass reduction objectives and or stability objectives:

- A secondary objective may be to reduce the volume and mass of waste that needs to be removed off-site. This objective is project specific, for example at a remote site where waste must be carried out by helicopter, volume and mass reduction is an important priority.
- A certain level of stabilization may also be specified in order to reduce risk when transporting residual organic matter.

For off-site discharge, process documentation is not necessary and maintenance involvement by the AP is simplified.

C- 1.3.2.2 On-site discharge

For on-site burial or on-site surface discharge, in addition to volume and mass reduction, it is also essential for the composting process to produce material that is:

- Stabilized;
- Matured; and
- Sanitized

to meet the standards or guidelines of this Manual.

For example, for a batch system with on-site discharge, the following objectives might be established:

- Residual organic matter to meet minimum quality standards of Table B- 14 (*list objectives*)
- Process to be batch composting with 2 year curing step
- Process to be documented by recording temperature and moisture at weekly intervals
- Residual organic matter to be tested, prior to discharge, following standards of Table B- 14 (*list test protocols*)

Secondary objectives are developed and stated as part of planning the system.

C- 1.4 System capacity guidelines

C- 1.4.1 INTRODUCTION

Composting toilets receive feces, toilet paper and urine. In some cases, bulking agents, food wastes or other materials are added. For the purpose of this Manual "feces" is considered to include toilet paper.

Composting toilet systems may be installed together with urinals. In other cases, urine may be diverted in the composting toilet collection or conveyance system. The result is less urine flowing to the composting processor. Diverted urine needs to be discharged to a wastewater system.

Some composting toilet systems use water-borne transport of excrement and toilet paper, with the added water being separated. This results in effluent, "water separated from blackwater", which needs to be discharged to a wastewater system.

Composting toilet processors may produce leachate. This leachate needs to be handled by the composting toilet system and, if not evaporated, discharged to a wastewater system. If micro flush toilets are used, more leachate may be produced.

In order to properly size and specify a composting toilet system it is necessary to estimate the excreta average daily design volume and the volume of any additives that will be used. In some cases, it is also necessary to determine the characteristics of the waste in order to plan and manage the composting process.

C- 1.4.2 VOLUME VARIATIONS, URINE DIVERSION AND FECAL SEPARATION SYSTEMS

C- 1.4.2.1 Volume in relation to diet

Fecal and urine volumes and mass values provided in this Manual are based on typical North American and European diet. If the occupants or users diet is atypical the AP should consider adjustments to the standard values. Fecal mass will increase with increased proportion of high fiber foods.

C- 1.4.2.2 Urine diversion and fecal separation

Urine diversion or separation systems will not attain 100% diversion of urine. A typical range is 50% to 95% diversion.

Partial urine diversion may be used, where urinals are used but urine is collected with feces during defecation. In this case an approximate 1:1.5 ratio fecal matter to urine (wet mass) is typical.

Fecal separation systems may be used to separate fecal matter and toilet paper from water closet flush water (blackwater or brownwater). Efficiency of separation is higher with short transport distances (reduced mixing), and typically ranges from 40% to 70% recovery of total excreta BOD and nutrients to the separated solid fraction.

C- 1.4.3 RESIDENTIAL WASTE ESTIMATION

C- 1.4.3.1 Estimation of occupancy for excreta volumes, and of design excreta volumes

For composting toilet systems, determine the SPM equivalent combined sewage DDF and the average excreta daily volume.

The SPM provides two options for estimating residential Daily Design Flow (DDF). See the SPM section II-5:

- The bedroom and floor area method
- The occupancy method

C- 1.4.3.1.(a)Bedrooms and floor area method

Select the SPM equivalent combined sewage DDF for the site and use based on number of bedrooms and floor area following SPM Table II-8. Then use this as a basis for estimating minimum number of occupants to use for calculation of average excreta daily design volume and bulk characteristics.

The minimum number of occupants is estimated as follows:

- From SPM Table II-9 select minimum occupant number based on number of bedrooms.
- If floor area exceeds maximum from SPM Table II-8, adjust occupancy by adding one occupant per each additional 300 m² of living area.

Use the number of occupants with Table B- 1 to establish average excreta daily volume.

Example of estimate of average excreta daily volume based on bedrooms and floor area:

3 bedroom house, 350 m² living area

From SPM Table II-8 (bedrooms and floor area) DDF 1300 L/day

Plus 3L/day additional flow for each square metre of floor area over 280 m²

Additional floor area = 350 m² - 280 m² = 70 m²

SPM equivalent combined sewage DDF = 1300 + (70 x 3) = 1510 L/day

Minimum occupancy for 3 bedroom house from SPM Table II-9 = 3.75 persons

Additional area to be considered = 70 m²

Added flow = (70 m² ÷ 300 m²) x 1 person = 0.23 additional persons

Total minimum occupancy = 3.75 + 0.23 = 4 persons

Average urine volume per day:

From Table B- 1 volume of urine 1.5 L/c/day

For 4 persons = 4 x 1.5 = 6 L/day

Average feces volume per day:

From Table B- 1 volume of feces 0.18 L/c/day

For 4 persons = 4 x 0.18 = 0.72 L/day

Average excreta daily volume = 6 L/day (urine) + 0.72 L/day (feces)

= 6.72 L/day

For this example, on the filing form declare either:

- SPM equivalent combined sewage DDF of 1510 L/day to include the composting toilet system and source separated wastewater system, or
- If filing for a composting toilet only, the average excreta daily volume of 6.72 L/day

C- 1.4.3.1.(b) Occupancy method

Estimate the occupancy based on declared site use and the minimum occupancy from SPM Table II-9. Select the SPM equivalent combined sewage DDF for the site and use based on number of occupants following SPM Table II-9. Then use the estimated number of occupants for calculation of average excreta daily design volume and bulk characteristics.

The minimum number of occupants is estimated as follows:

- From SPM Table II-9 select minimum occupant number based on number of bedrooms.
- Compare to the proposed occupancy declared by the owner and use the higher number.

Use the number of occupants with Table B- 1 to establish average excreta daily volume.

From SPM Table II-9 use the per person flow to estimate the SPM equivalent combined sewage DDF based on occupancy.

Example of estimate of average excreta daily volume based on occupancy:

<p>3 bedroom house, single family residential use</p> <p>Declared occupancy = 4 persons</p> <p>From SPM Table II-9 (per capita DDF) Minimum number of occupants = 3.75</p> <p>Per person flow (single family dwelling), SPM Table II-9, = 350 L/day</p> <p>Number of occupants selected = 4 persons</p> <p>SPM equivalent combined sewage DDF = 350 L/day x 4 persons = 1400 L/day</p> <p>Average urine volume per day:</p> <p>From Table B- 1 volume of urine 1.5 L/c/day</p> <p>For 4 persons = 4 x 1.5 = 6 L/day</p> <p>Average feces volume per day:</p> <p>From Table B- 1 volume of feces 0.18 L/c/day</p> <p>For 4 persons = 4 x 0.18 = 0.72 L/day</p> <p>Average excreta daily volume = 6 L/day (urine) + 0.72 L/day (feces)</p> <p>= 6.72 L/day</p>
--

For this example, on the filing form declare either:

- SPM equivalent combined sewage DDF of 1400 L/day to include the composting toilet system and source separated wastewater system, or
- If filing for a composting toilet only, the average excreta daily volume of 6.72 L/day

C- 1.4.3.2 Residential recreational waste

Residential recreational use sites (cabins used by a single family) will have waste volumes equal to those for residences, adjusted for length of occupancy.

C- 1.4.4 COMBINED VOLUME, WITH ADDITIVES

After the average daily excreta volume is estimated, estimate the average daily volume of additives.

The amount of additive used varies depending on the process and usage patterns. If urine is diverted, normally less additive is used. Some systems do not use additives; other systems may add food wastes.

Follow manufacturer or specific open source system design guidelines to estimate volume.

As a guideline, for a residential commode collection system collecting combined excreta with bulking agent or cover material, allow 0.25 to 0.75 L per use or up to 3L per person per day bulking or cover material. This is a volume for untreated material, and is suitable for sizing the collection system.

The calculated volume is conservative for sizing of a composting processor, since the volume does not include allowance for volume reduction during the composting process.

C- 1.4.5 PUBLIC USE SITE WASTE ESTIMATION**C- 1.4.5.1 Estimation of combined values**

Public use site waste received by toilets that do not divert urine may have higher proportion of urine than for residential sites. Urine volume per use may also be higher. This is particularly the case for day use sites. Parks and other recreational or seasonal sites will have seasonal use patterns which need to be addressed in system planning.

Defecation events are most common in the earlier morning, so sites which are not open at that time will see a higher proportion of urine to feces.

When estimating waste volume and characteristics, estimate number of events per person per day and number of users for average and peak weeks and average and peak days. Urination events are more frequent for children, less frequent for adults. Adjust per use values if standard values are not representative of the site use (e.g. a children's day use camp).

When estimating urine volumes for collection and processor system sizing, multiply the volume calculated from the adopted values in Table B- 2 by 1.5. This will provide a safety factor.

Base urine diversion calculations on diversion efficiency, see Section C- 2.3.2. For sites with urine diversion, consider combining one urination event with defecation event.

Bulking or cover additive use at public use sites is higher. As a guideline for systems where bulking or cover material is provided for public use, allow 1 L of loose bulking agent per use.

C- 1.4.5.2 Non-excreta waste deposits

Public use sites may have a high risk of receiving non-biodegradable wastes (trash). It may be necessary to add capacity allowance for trash.

C- 1.4.6 CHARACTERISTICS OF COLLECTED WASTES

Depending on the type of composting toilet system and process it may be necessary to estimate the characteristics of collected waste, such as the carbon to nitrogen ratio or nitrogen content.

For on-site surface discharge it may be necessary to estimate the expected metals content of the residual organic matter.

C- 1.4.6.1 Excreta characteristics

Table C- 1 provides typical values of key parameter for excreta. Typical values for metals levels in residential excreta are provided in Table C- 2.

Table C- 1. Typical and adopted parameters for excreta

PARAMETER	FECES, PER DAY PER CAPITA		URINE, PER DAY PER CAPITA	
	RANGE	ADOPTED VALUE	RANGE	ADOPTED VALUE
Wet mass (g)	100 - 400	180	500 - 2000	1500
Dry mass (g)	30 - 60	50	20 - 147	60
Volume (L)	0.1 – 0.4	0.18	0.5 - 2	1.5
COD (g)	19 - 64	40	5.4 - 30	10
BOD ₅ (g)	6 - 18	14.4	1.8 – 13.6	5
BOD ₅ (mg/L)				3300
C:N ratio	5 - 11	7.5	0.4 – 1.2	0.7
Total Nitrogen (g)	0.25 - 7	1.5	3.6 - 19	11

Note: Adopted values are medians, and do not include a safety or peaking factor.

Nutrient levels are related to diet. Approximately 10-20% of dietary Nitrogen will be found in the feces. Total nitrogen level in excreta may be estimated as: total N = 0.13 x total food protein.

For calculation of C:N ratio see: http://compost.css.cornell.edu/calc/cn_ratio.html.

Total carbon content for typical biological materials may be estimated as 55% of the volatile solids (VS) fraction, so if volatile solids content is known then the % carbon can be estimated as follows:

Where % VS = 100 - % Ash, then % Carbon = (% VS) ÷ 1.8

Table C- 2. Typical metals levels for residential excreta

PARAMETER	UNIT	FECES, PER DAY PER CAPITA	URINE, PER DAY PER CAPITA
		TYPICAL VALUE	TYPICAL VALUE
Cu	mg	1.1	0.1
Cr	mg	0.13	0.01
Ni	mg	0.19	0.011
Zn	mg	10.7	0.3
Pb	mg	0.04	0.012
Cd	mg	0.01	0.0005
Hg	mg	0.009	0.00082

The main proportion of heavy metals consumed are excreted in the feces, with 5 to 15% of consumed quantity being found in the urine. In comparison to combined municipal sewage or sludge, source separated fecal matter and urine are low in heavy metals.

C- 1.4.6.2 Additive characteristics

Additives may include bulking or conditioning additives, additives used to adjust carbon to nitrogen ratio, fermentation additives, food scraps or garden wastes added for carbon content or with a co-composting objective. See Section C- 1.6.8, page 66, for typical bulking agents. The available carbon content of some materials may be considerably lower than the total carbon content, particularly woody materials.

For characteristics of common additives, refer the design manuals referenced in Section D- 2 or to:

Cornell University composting information <http://compost.css.cornell.edu/OnFarmHandbook/apa.tab1.html>

Additives may add metals to the composting process. This should be taken into account when selecting bulking agents. For example, some sawmill wood shavings have been found to contain high levels of Zinc.

C- 1.4.7 SYSTEM CAPACITY

Base sizing for collection, conveyance and processor components on manufacturer guidelines or open source manuals for the selected process, adjusting to address any particular characteristics of the proposed site use.

Determine container collection system capacity considering:

- Excreta volume
- Additive volume
- Headspace needed
- Time target for container replacement
- Safety factor

Determine composting processor capacity considering:

- Excreta volume
- Additive volume
- Volume reduction by composting process
- Headspace needed
- Time target for container or bin use (if a batch process) or for removal (if a continuous process)
- Safety factor

Add the estimated volume of additives to excreta volume to calculate average daily total waste volume that is collected. Additives may absorb the urine volume, and (in some systems) excess urine may flow to leachate collection, so actual accumulation volume may be bulking agent plus fecal matter and toilet paper.

C- 1.4.7.1 Volume reduction

Volume reduction during the composting process varies, particularly depending on whether the processor achieves at least mesophilic temperatures resulting in some degradation of organic matter. A range for systems achieving composting or degradation is 35 to 50% volume reduction. Mass reduction will be lower than volume reduction. Woody and other high lignin content materials will not decompose fully during composting, this results in lower volume reduction for these types of bulking agent.

For composting processes that do not employ bulking agents, and which divert urine, accumulation rates will be considerably lower. For example, in the case of a urine diverting system with no bulking agent added and with effective degradation, residual organic matter after 10 years may be as low as 100 kg/capita, or 375 kg for an average 3 bedroom house.

C- 1.4.7.2 Headspace

Headspace is needed in many processors to allow safe access, maintenance and mixing. Adequate headspace is also needed in containers to allow safe conveyance (without spilling or contact with waste).

C- 1.4.7.3 Proprietary system capacity rating

Some proprietary toilet systems state capacity in number of uses per day.

European proprietary toilet systems typically state capacity in terms of person equivalents. 1 person equivalent (p.e.) for “person days” capacity stated for these systems is based on 1.2 defecation and 4 urination events per day. Volumetric capacity of the collector and processor for these systems is based on approximately 800 L fresh excreta per year per p.e.

C- 1.4.7.4 General capacity guidelines

C- 1.4.7.4.(a) Container collection systems

Container size should be adequate for minimum:

- One days use at peak use, two days at average use for residential system
- 2 x number days at peak capacity between planned collection times for public use systems

Provide extra containers if high peaks are expected (e.g. large parties).

Residential commode systems or other systems collecting excreta with a bulking agent should allow a capacity of at least 3.5 L/c/day for the collection container. Bulking or cover additive use at public use sites is higher. As a guideline for systems where bulking or cover material is provided for public use, allow 1 L of loose bulking agent per use.

Consider the physical or mechanical needs for conveying and emptying containers.

C- 1.4.7.4.(b) Other systems

For dry toilets used to collected feces for composting, base capacity on the planned period of use prior to transfer to the composting processor.

Batch bin systems, with collection direct to dedicated bin composting processors, typically have a bin capacity of at least 1.5 L/day per person.

For incinerating toilets with incineration in unit, capacity should be adequate to contain and incinerate peak day use.

C- 1.4.7.5 Peaking factors and safety factors

Peaking of use for composting toilets is not normally an issue for total volume of the processor, but may affect operation where short term peaks are high—particularly if urine is not diverted. Batch processors are frequently more flexible to varying demand, in that additional containers or piles can be added. If small containers are used for collection, peak use may reduce the fill time to the point where a larger container may be preferable.

Peaking of use for public use sites may have a more significant impact, and peaking of urine (or leachate) volumes also needs to be addressed.

Ensure that the system can accept peak usage and still:

- Achieve planned decomposition
- Achieve planned performance objectives
- Meet expected service intervals (e.g. minimum period between emptying containers)
- Avoid impact on the function of ventilation, access ports etc.

Peak use events with high urine volumes retained in the composting processor may affect the composting process itself, due to:

- Excess moisture content and reduced aeration
- Build-up of ammonia reducing microbial activity

Some sites may have widely fluctuating use. For example, a summer cottage may see intense use for a short period, and no use for the rest of the year. For these situations, consider the highest use (peak) week and estimate the average daily use for that week.

Prediction of volume reduction may not be accurate, and use of bulking materials may vary depending on the user. Consider the potential risk related to an undersized system, and potential process impact of an oversized system. Base system capacity on conservative assumptions, or include a safety factor. The level of risk affects the choice of appropriate safety factor.

For example, a process that can readily be scaled does not need as large a safety factor as one that cannot be scaled. Batch systems are, in some cases, able to be scaled to add capacity by adding extra containers or piles. However, there may be a practical limit placed by individual container capacity and the need to change or empty containers. Scaling a continuous process system is typically not practical.

C- 1.4.7.6 Example of estimating minimum capacity

For the following system:

- Batch process
- Collection of urine and feces by container
- Residential use with instructions for addition of 0.5 L bulking agent per use, estimated 5 uses per day per person
- Household per example in Section C- 1.4.3.1.(a) on page 55, with 4 person occupancy
- Time target for container replacement 2 days

C- 1.4.7.6.(a) Collection container

Collection container size based on no digestion during initial collection period, but with urine absorbed by bulking agent or otherwise filling air spaces in the collection container:

<p>Feces volume per day (from Table B- 1)</p> <p>= 0.18 L/day per person</p> <p>Bulking agent volume per day = volume per use x uses per day = 0.5 L/use x 5 uses/day</p> <p>= 2.5 L/day</p>
--

$$\begin{aligned} \text{Volume per person per day} &= \text{feces volume per day} + \text{bulking agent volume per day} \\ &= 0.18 + 2.5 = 2.68 \text{ L/day} \end{aligned}$$

$$\begin{aligned} \text{Volume collected per day} &= \text{volume per person per day} \times \text{number of occupants} = 2.68 \text{ L/day} \times 4 \\ &\text{persons} = 10.72 \text{ L/day} \end{aligned}$$

Consider guidance from Section C- 1.4.7.4 which recommends minimum container capacity of 3.5 L/day per person for commode systems.

$$\text{Recommended container capacity} = 3.5 \text{ L/day} \times 4 \text{ persons} = 14 \text{ L/day.}$$

Based on this estimate, and considering the guidelines, a 30 L pail would allow 2 days collection with a headspace allowance. Alternatively, two 20 L pails could be used in a commode that housed the pail in use plus a spare.

A site specific peaking factor should be estimated to ensure container emptying will not be needed more than once a day during peak use.

C- 1.4.7.6.(b) Composting processor

Composting processor rough size estimate based on initial capacity and a target maximum 6 months addition:

Gross volume for 6 months, based on collection volume and with leachate (excess urine) discharged

$$= \text{collected volume per day} \times 180 \text{ days} = 10.72 \text{ L/day} \times 180 = 1929 \text{ L}$$

With no allowance for added cover material used during addition phase this equates to a 2 m³ bin or pile, a pile 1.5 m square by maximum 1.5 m high would accommodate this volume with headspace.

During addition, digestion will be occurring and may offset any further added material. Not allowing for this volume reduction results in a conservative system capacity estimate.

If volume reduction of approximately 40% occurs during the composting process, overall volume of residual organic matter for discharge from the pile after composting and curing would be:

$$= 1929 \text{ L} \times (1 - 0.4) = 1157 \text{ L}$$

The standards of Section B- 1.6 specify that additional capacity or space is to be set aside for separate pile processors, which provides an additional system capacity safety factor for this type of processor.

C- 1.4.8 VAULT TOILETS AND DRY TOILETS

Information in this section may be used to estimate required holding tank capacity, based on no volume reduction in storage.

C- 1.5 System selection guidelines

C- 1.5.1 INTRODUCTION

Composting toilet systems are selected to meet the primary and secondary purposes and objectives.

Selection of composting toilet systems includes selecting and specifying a process or series of processes. It is necessary to consider how the chosen processes will result in achieving the purposes and objectives that have been defined for the system.

Selection rationale may be used as part of documentation of an alternative solution under the BC Building Code.

C- 1.5.2 TYPE OF PROCESS

A wide variety of processes may be used to result in a particular outcome. For example, several different sanitizing methods may be used to produce material suitable for on-site discharge. It is important to consider potential performance constraints for each type of system and type of process, for the specific site use.

C- 1.5.2.1 Temperature

Composting and digestion processors operate better at higher temperatures. In some cases high temperature may be a necessity for proper performance. Temperature may be needed for stabilization, maturation and pathogen attenuation. The time to achieve these objectives, or whether they are achieved at all, is affected by temperature.

For example, a thermophilic step may have been specified as a sanitizing step, and so to achieve the planned objective a specified temperature will need to be achieved for a minimum time period.

When selecting a system, determine how temperature is to be maintained. Consider how air exchange (ventilation), which is also critical, will affect temperature.

On the other hand, for some processes it is unlikely that a thermophilic stage will occur. For these systems, there is no purpose in wasting energy on heating the processor and the added heat may result in unwanted drying of the collected material. If sanitizing is needed to meet performance objectives, a longer curing time or an alternative sanitizing step will need to be selected.

C- 1.5.2.2 Capacity and scaling

Consider the site use and required capacity, and potential need for future expansion of capacity. For all systems, but particularly for commode and container collection systems, servicing frequency is a critical factor for public use sites.

C- 1.5.2.3 Seasonal use

For seasonal use, consider operational needs in the off season. A process that relies on passive composting and curing may be more suitable. If material will be left in the composting processor for extended periods, specify equipment or procedures to ensure dehydration will not cause material to become very hard and difficult to manage.

C- 1.5.2.4 Public use sites

Public use sites and small commercial systems have different characteristics from smaller residential systems, and selection of a composting toilet system and process should take into account projected type of usage—seasonal vs all season, day use vs 24 hour use, risk of high peaks, maintenance and servicing needs etc.

C- 1.5.2.5 Remote sites

Remote sites may have limited availability of bulking agent, and have high cost for off-site discharge of residual organic matter. These considerations may lead to the selection of urine diversion and processes that need little or no bulking agent and which achieve significant volume and mass reduction.

C- 1.5.3 GENERAL SELECTION GUIDANCE

The *Composting Toilet System Book* and *Guidance for Composting Toilet and Greywater Systems in BC* (see Appendix D- 2) include comprehensive advice and information on system selection.

The NSF provides testing of composting toilets (NSF Standard 41), also adopted by CSA. Other standards bodies also provide testing in Europe and Australia/New Zealand. Some commercial composting toilets have been tested following one or more of these standard protocols. When selecting a proprietary composting toilet system which has been tested, obtain testing results from the manufacturer. Certification alone provides no assurance of performance under site specific conditions.

When selecting a system, consider where it will be installed. Some systems require considerable height below the pedestal and are therefore only practical where that space is available. In the case of systems with access doors to remove residual material, or large access doors for hand mixing or other interventions, plan to allow easy access for maintenance and reduce risk of contaminating the living space with wastes. Select the system to minimize maintenance activities which place an individual in close contact with waste.

C- 1.5.4 OPERATION AND MAINTENANCE AND OWNER CONSIDERATIONS

A critical factor for satisfactory system performance is operation and maintenance. Composting toilet systems vary widely in the type and intensity of operation and maintenance needed. System life cycle costs can also vary widely.

It is important to inform the owner about operational needs and costs, and to confirm that the owner or system user will operate the system properly. In many cases, the owner will have a stated preference for type of system or type of toilet pedestal.

C- 1.5.5 CONSIDERATIONS FOR FUTURE SITE USE

Discuss with the owner potential future uses of the building or dwelling. Although a composting toilet system is a long term sustainable solution for waste management, future owners may wish to use a water borne system.

In some cases, the owner may choose to plumb and configure the building to allow for retrofit of water closets, in order to provide flexibility of options for future owners. Likewise, the owner may choose to size the wastewater system dispersal area to allow for future addition of blackwater flows, and to site septic tanks to allow addition of a blackwater tank at a future date. If or when a tank is added, a new filing will be needed for the tank installation.

C- 1.6 Specification and Installation guidelines**C- 1.6.1 INTRODUCTION**

Given the wide range of available system options, the standards cover only critical factors, and in many cases the standards are outcome based:

- It is important to consider how system specification and installation support the primary and secondary purposes for the system when determining how to meet the outcomes.

- It is important to record the rationale for how the system will meet the prescribed outcomes, based on the specified components.

C- 1.6.2 COMPOSTING TOILET STRUCTURES AND THE BC BUILDING CODE

Composting toilets and composting processor units may require structural and ventilation considerations.

Contact the authority having jurisdiction (AHJ) (typically the local government building inspector) to inquire over permits. Structural, access and ventilation aspects of the composting toilet unit and toilet room for buildings requiring a building permit must either meet the BCBC or be approved as an alternative solution by the authority having jurisdiction. See the Appendix Section D- 4.1.

The BCBC does not apply to “*accessory buildings less than 10 m² in building area that do not create a hazard*”, contact the AHJ to determine whether a permit is required for buildings under 10 m².

C- 1.6.3 PEDESTAL SEAT

The composting toilet pedestal seat may be sealed, or provided with an air gap. Selection depends on ventilation specified:

- If venting draws air from the room through the pedestal, the seat is not sealed and has adequate gap to allow ventilation air to pass through. A screened insert may be needed to help control flies.
- If venting draws air from another source, e.g. from outside the building, the seat is to be sealed to the pedestal. Signage should emphasize the need to close the seat after use.
- Where a trap or seal (water or mechanical) is used between the pedestal and collector, the seat can either be sealed or not.
- In some cases, venting may be needed to prevent condensation forming on the seat cover.

C- 1.6.4 COLLECTION SYSTEM, PEDESTAL CONVEYANCE

It is important to specify a collection system (e.g. chute) in the pedestal that does not encourage excreta to accumulate and allows for easy cleaning. This includes any urine diversion system. Fly and other vector issues will arise if excreta accumulate in the pedestal or conveyance system.

The standards specify that there should be no possibility of accidental contact with waste. Ensure there is adequate distance between the maximum height of the compost mass and the top of the pedestal.

C- 1.6.5 COLLECTION SYSTEM, CONTAINER

If a container (bucket or commode) collection system is used, the owner or maintenance provider will be moving fresh or partially stabilized material. Specify precautions to reduce health risk as well as to avoid environmental contamination.

Consider the following when specifying a container collection system:

- Provide a spare collection container to allow servicing
- Estimate servicing (collection) interval and provide storage for spare containers

C- 1.6.6 VENTILATION

Where practical, follow USDA Sweet Smelling Toilet techniques, particularly for passively or convection vented systems, see the *SST Installation Guide* available at: <http://www.fs.fed.us/eng/pubs/pdf/03231303.pdf>

Ventilation is essential to provide gas exchange, which is essential for aerobic composting processes. It is also important for odor and vector control. Venting needs to be continuous for both purposes.

Venting to the exterior of the building is necessary to meet the BCBC, and to control odours. As a guideline, vent discharge should be minimum 60 cm above the highest elevation of the roof within 3 m of the vent.

Venting design should maximize contact of air with the composting material. In some cases, separate ventilation systems are used for aeration (via the compost pile) and odor control (via the pedestal seat).

Common ventilation systems are:

- Electric fan, inline suction or pressure
- Vent stack with turbine vent
- Convection systems using dark colored passive vent stack combined with favorably oriented intake vents (USDA sweet smelling toilet ventilation system)

When planning ventilation systems for composting toilet processors consider the following points:

- Avoid excessive cooling and drying of materials.
- Do not rely on ventilation alone to manage leachate unless a leachate evaporation system is specified
- Ensure that a leachate evaporation system (or heating system) does not result in excessive drying of composting materials.
- How the ventilation system may affect the building ventilation system, particularly the need for extra make up air.
- How the building ventilation system may affect air flow in the composting toilet, particularly the risk of pulling air up out of the pedestal into the room.

C- 1.6.7 ACCESS FOR OPERATION AND MAINTENANCE

Poor access is a key constraint for proper maintenance, and therefore system performance.

Contact with or contamination of the building by wastes during maintenance results in a health risk. Consider access and maintenance operations with the objective of avoiding health risk and, particularly, of avoiding contaminating the building with wastes or gases.

Where access panels are provided, ensure they are sited so material does not build up against them and fall out when the panels are opened.

C- 1.6.8 PURPOSE AND DESIRED CHARACTERISTICS OF BULKING AGENTS

Bulking, cover and conditioning agents are primarily added to improve structure and aeration of the material in the composting processor, and to absorb and control moisture.

They may also be used to cover collected excreta or composting materials. Some of these additives may improve the C:N ratio of the mixture. However, in many cases the carbon in the additive is not rapidly bioavailable.

Bulking agents should be absorbent, structurally strong and low density, and should not be of a composition:

- That will result in the organic matter in the composting toilet processor becoming compacted
- That will impair microbial or other biological activity needed for the process

Cover materials may be the same as bulking agents, but may also be structurally weaker materials such as shredded news stock.

Examples of favourable bulking, cover or conditioning agents include:

- Hardwood or fir, hemlock, spruce, alder shavings and chips, including bark
- Biochar
- Shredded news stock, shredded plain cardboard
- Shredded leaves and dry mulch

Examples of unfavorable bulking, cover or conditioning agents include:

- Pressure treated wood residues
- Shredded glossy or colored printed paper
- Wet (rather than moist) materials

Suitability of materials depends on the process. For example, sawdust may be suitable as a cover or bulking agent for pile composting processors where the pile is actively mixed, but may be less suitable for a passive bin composting processor.

Cedar wood products may be usable if matured or partially rotted, fresh cedar products may, in some cases, not be suitable.

C- 1.6.9 NON-EXCRETA WASTE DEPOSITS

Address the risk of disposal of non-biodegradable wastes (trash) to the toilet:

- Include prominent signage
- Consider specifying a toilet pedestal that discourages disposal of trash
- Provide alternate disposal options for trash
- Avoid adding to the risk, for example, do not provide paper towels or towelettes.

C- 1.6.10 DRY TOILETS

Dry toilets may be used as a type of vault toilet system (with off-site discharge). They may also be used with incineration as a final step. Alternatively, they may be used as the pedestal and collection system for a composting toilet system, with batch composting of the collected, dried, fecal matter.

Dry toilets rely on air drying of collected feces. Ash or lime may be added to assist in drying and to control odours and insects. pH adjustment by the addition of ash or lime, with drying, reduces pathogen levels, and so reduces risk when removing material from the toilet. There is a risk of re-growth of pathogens when the dried material is wetted. Also, dry toilets may not produce stabilized residual organic matter. For these reasons dry toilets need to be supplemented with another process if on-site discharge is planned.

As a guideline, if ash is used in a dry toilet, approximately 0.2 to 0.5 L is added after each defecation. Smaller volumes are needed for lime addition. Automatic ash or lime dispensers may be used.

Toilet paper is typically diverted, but in some cases may be collected in the toilet. If lime or ash additive is to be used, diversion of toilet paper will improve odor and vector management impact of the additive.

If the collected material is to be composted, avoid adding ash or lime as the additive will cause very high pH and negatively impact composting. Earth, charcoal or biochar addition may be used. See Section C- 1.7.6.1.(b) for further information on pH adjustment.

C- 1.6.11 SEPARATE PROCESSORS

Specify the process to be followed, for example, thermophilic composting step followed by curing. Specify the size and number of processors to allow for addition of material, then for processing at thermophilic and mesophilic temperature (depending on process specifications) for specified time plus specified curing time for each batch.

For residential sites, using an open container pile type processor, 4 processors typically allow for a 2 year cycle of batches.

C- 1.6.12 SEPARATE OPEN CONTAINER PROCESSORS

Open container pile or bin systems are typically 1.5 m x 1.5 m with a planned maximum height of 1.5 m. For an open container bin system serving a public use site or more than one residence, larger bins of 2 m x 2 m (or equivalent area) are suitable.

The base of the processor may be on an absorbent biological mat to provide leachate filtration and treatment prior to discharge to the leachate collection system. The mat material is eventually incorporated into the compost. If rainfall input is to be allowed to the processor, calculate planned rainfall input which is predicted to percolate through pile on peak rainfall day (if any) and add to leachate wastewater system capacity.

In wet winter climates a roof or other cover system that diverts rainfall without restricting ventilation may be needed. Rainfall may negatively impact the process in several ways:

- Cooling of the process
- Filling of pore spaces with water, restricting ventilation
- Increased leachate volume
- Increased leaching of nutrients and composting microorganisms

Cover material is needed to control odour, retain moisture and restrict vector access. Specify cover materials and procedures for addition of fresh waste and re-covering.

To prevent vector access by larger vectors (e.g. rodents or pets), a tightly fitting screened or vented cover may be needed. All screening material should be resistant to rodent and other animal attack. Stainless steel insect screening is suitable. Alternatively, 12 mm welded mesh (hot dip galvanized or stainless) may be used to back up other corrosion resistant insect screen.

C- 1.6.13 INCINERATING TOILETS

Diversion of urine is strongly recommended for incinerating toilet systems.

C- 1.6.14 HAND SANITIZER

When selecting products, take into consideration products that have been tested to meet food contact safety standards.

Do not provide sanitizing wipes due to risk of disposal to the composting toilet. This could negatively impact the composting process and result in environmental pollution.

C- 1.6.15 URINE TREATMENT

Separately collected or diverted urine may be treated, including by struvite process or composting, prior to discharge. For composting processors treating urine separately from fecal matter, follow the specification and installation standards and guidelines for composting toilet processors.

C- 1.6.16 USERS AND ACCESS

Consider the following when specifying and installing a system:

- Install signage to identify biohazard risks
- Provide signage permanently attached in a prominent location describing how to use the toilet and, if applicable, how to add bulking agent or other additives
- Check that users can safely and hygienically access and use the toilet
- Where necessary, provide suitable access to meet the BCBC for people with disabilities

C- 1.7 Residual organic matter processing guidelines**C- 1.7.1 INTRODUCTION**

This section addresses processing for stabilization and pathogen reduction after or as part of a composting process. The type of process is based on the standards for the chosen discharge method and secondary objectives for the system, see Section C- 1.3.2. See Figure C- 1, Page 73, for an introduction to the process options.

If on-site discharge (burial or surface discharge) of residual organic matter is planned, specify a batch curing process, incineration or a batch sanitizing process (see Section C- 1.7.6).

If off-site discharge is planned, sanitizing or curing is not a necessity, but can be used to make material safer to handle during discharge, or to provide volume and mass reduction.

C- 1.7.2 HEALTH AND HYGIENE PRECAUTIONS DURING PROCESSING AND HANDLING

See Section C- 1.9.1.

C- 1.7.3 ASSESSING MOISTURE CONTENT

Moisture content of composting material is most accurately evaluated by testing. To test moisture content, weigh a sample of moist material, dry and then re weigh.

For rapid assessment during initial composting a simple moisture meter probe can be used. Visual inspection will also indicate whether the material is too wet or too dry:

- Too wet, visible liquid in the processor, anaerobic odor.
- Too dry, feces and toilet paper visible and building up, degradation not occurring.

For rapid assessment of composting material during the curing step the squeeze test is accurate enough (within 5%) for management purposes.

Squeeze a representative sample of compost between your hands (wear gloves and follow hygiene practice standards of this Manual):

- If the squeezed material crumbles, does not hold together and your gloves feel dry, moisture content is at 40% or less.
- If the squeezed material sticks together and your gloves feel moist, moisture content is approximately 50%
- If the squeezed material sticks together and water drips out, the material is at 60% or above.

The behaviour of composting toilet materials varies, depending on type of process and bulking agents, so these simple tests and inspection should be adapted to your experience with the particular process. This experience can be used more accurately if based on testing of samples.

C- 1.7.4 GUIDELINES FOR INCINERATION

The purpose of incineration is to reduce organic matter to ash, and to kill pathogens. Incineration can be applied to stabilized residual organic matter or to fresh excreta. Incineration does not refer to the process of making biochar from composted or fresh excreta.

Residential incinerating toilets collect and incinerate excreta. Collected feces or residual organic matter may also be incinerated in a separate batch process.

When selecting an incinerator or incinerating toilet, ensure the unit is appropriate for the climate and is capable of serving the expected use.

Odor from incineration will need to be addressed, by high level vents, biofilters or other methods.

Incinerated material is to be tested prior to on-site discharge. It may be more efficient to accumulate a batch of incinerated material and then test that batch prior to burial.

C- 1.7.5 GUIDELINES FOR CURING

In the curing (also known as maturation, secondary composting or holding) process, batches of partially stabilized organic matter from a composting processor are held in an aerobic state at an appropriate moisture content. Typically, this step occurs after the thermophilic composting stage, at mesophilic temperatures and cooling to ambient (psychrophilic) temperatures.

The curing time allows for further stabilization and maturation, and for die off of pathogens.

For composting processors that reliably meet the thermophilic step standards, the pathogen reduction during that step allows for reduced curing time. Curing is still needed to further reduce pathogens and to allow the compost to stabilize and mature.

For continuous process composting toilets this step also removes the organic matter from the risk of recontamination by leachate percolating from new additions of fresh excreta.

For batch process systems, curing may be a continuation of the composting process. In order to meet performance objectives for on-site discharge there may be an extension of processing time for the batch compared to the processing time prior to off-site discharge.

C- 1.7.6 GUIDELINES FOR ON-SITE SANITIZING OR DISINFECTION

Waste may be sanitized by one of the following processes:

- Time at temperature:
 - A thermophilic step followed by curing
 - Pasteurization
- pH adjustment
- The application of urea to create high ammonia levels

The sanitizing step is planned to meet the objectives established for residual organic matter. Defined objectives depend on the planned discharge method for the residual organic matter.

For on-site discharge the sanitizing step or process is an alternative to or a supplement to long term curing.

Documentation of the sanitizing step is important to confirm that adequate sanitation has been achieved. For example, data-logging for record of temperature can be used to provide confirmation that temperature targets were consistently achieved.

C- 1.7.6.1.(a) Time and temperature

Pathogen attenuation due to temperature effects in composting is related to time at a certain minimum temperature. For example, 1 hour at 62 °C, 1 day at 50 °C, and 1 week at 46 °C will be lethal to all pathogens (except in some cases viruses at very short retention times).

A thermophilic step may be specified, with temperature maintained by microbial activity alone or with supplemental heating. Pasteurizing is typically specified as a shorter time period at a higher temperature, with temperature achieved by heating the material.

It is necessary that all parts of the compost reach the required temperature for an adequate period time.

It is important that the material has adequate moisture content. Dry material will require a longer period at a certain minimum temperature for the same level of disinfection. For pasteurizing, it is also important not to have excess of moisture, with a target of 60% being ideal.

C- 1.7.6.1.(b) pH adjustment

A pH above 9 reduces microbial activity and increases the effect of ammonia (naturally present from urine, or added) on microbes. To achieve a sanitizing effect from pH, a pH of 11 – 12 is desired. pH adjustment can be accomplished through the addition of lime or ash.

Lime may be quicklime, hydrated lime or a suspension of hydrated lime (slaked lime). The minimum lime application rate specified is for dry hydrated lime. Specify safe handling procedures if using quicklime.

Ash or lime added to fecal matter reduces smell, reduces moisture content, reduces insect and other vector attraction and elevates pH. Pathogen attenuation for solids after lime or ash application is related to the reduced moisture content (less than 60%) and to the elevated pH.

Addition of ash or lime to un-stabilized waste may reduce microbial content but the pH adjustment may have restricted bacterial activity that is needed to stabilize and mature the organic matter.

For this reason, the pH adjustment standard for systems with on-site discharge specifies stabilized residual organic matter prior to addition of lime or ash. After the addition of the lime or ash, a short (60 day) period of holding is needed for pathogen attenuation. This allows for reduction of the total curing/holding time from 1.5 or 2 years to 2 to 4 months. pH adjustment has been demonstrated to have sanitizing effect at lower temperatures, which is the reason no temperature standard is specified.

Addition of ash or lime provides added nutrients for plant growth, but in dry climates or where soils are already alkaline, the addition of high pH residual organic material could have negative impact on plants.

C- 1.7.6.1.(c) Urea and ammonia sanitizing

In this process urea fertilizer is added to stabilized residual organic matter. The added urea hydrolyses to produce ammonia, which in turn provides the sanitizing effect. It is important that the material is moist and that temperature is maintained, in order to ensure adequate and rapid conversion of urea to ammonia. Temperatures between 24 and 34 °C are preferred. Where practical, consider exposing containers to the sun to keep temperatures high. Longer storage with high ammonia content will increase the sanitizing effect, and may help to compensate for lower temperatures.

The material being treated should be closely covered, preferably in a sealed container to retain ammonia and reduce odour issues.

It is preferable, and for on-site discharge required, to apply this step to stabilized residual organic matter so that mixing will be easier, regrowth of bacteria will be less likely and because stability testing is required prior to on-site discharge.

Breakdown of urea to ammonia and evolution of ammonia is related to pH. Once the urea has been broken down to produce ammonia, the sanitizing effect of ammonia is improved at higher pH. In general, the specified 2% urea addition will result in adequate pH. However, once the urea has been hydrolysed to ammonia, it is safe to add ash or lime to increase pH and this will increase and speed up the sanitizing effect of the ammonia.

In some cases, depending on diet (e.g. vegetarians), pH of feces may be lower than normal, and additional urea may be needed—this is the reason the standards specify minimum 2% urea. If pH in the material is very high (for example due to ongoing ash addition during collection) urea treatment may not be successful due to reduction of urea hydrolysis to ammonia.

Added urea increases the fertilizer value of the residual organic matter, but potential risk to the environment should be considered, see Section C- 2.5.4, page 95.

C- 1.7.6.1.(d) Anaerobic digester systems

For anaerobic digester systems with on-site discharge, waste is either pre-processed by pasteurization or post-processed by composting and curing or a sanitizing/disinfection step.

C- 1.8 Discharge guidelines for residual organic matter

C- 1.8.1 INTRODUCTION

Figure C- 1 below shows options for processing and discharge of residual organic matter.

Figure C-1. Composting toilet system residual organic matter discharge

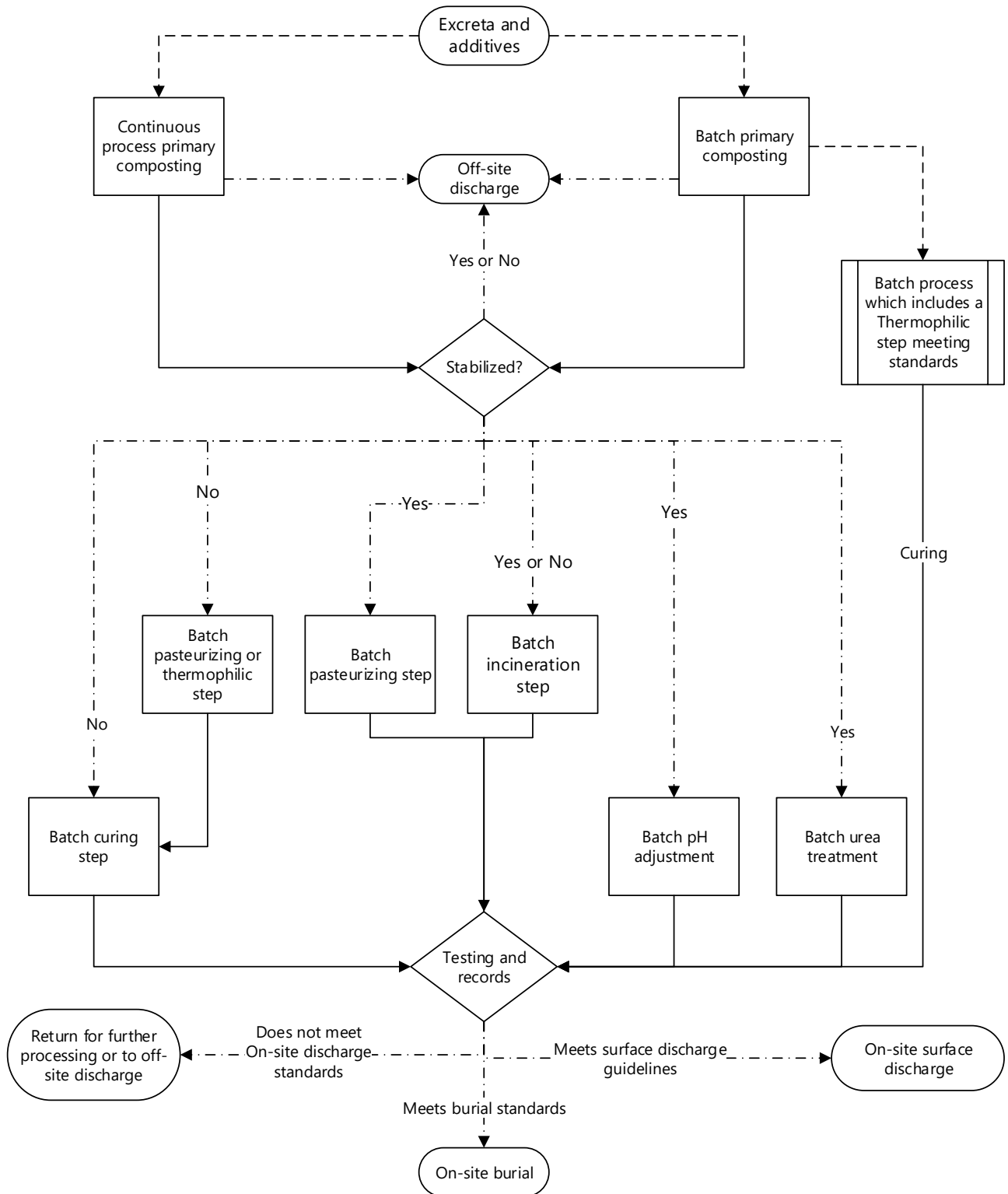

C- 1.8.2 OFF-SITE DISCHARGE

Off-site discharge means off-site removal of residual organic matter from the composting toilet system to an approved facility.

Conveyance of materials during collection or between steps of the composting process is not “off-site discharge”, even if material is moved from the composting toilet site. For example, a community composting toilet system might include conveyance of materials collected by commodes at individual sites to a central location for composting and curing.

An “approved facility” includes a wastewater treatment plant which receives sludge (as for septic tank sludge), a sanitary landfill or an approved composting facility which is permitted to receive the waste material.

To reduce costs and frequency of disposal, specify the composting processor to improve volume reduction. This may be particularly important for remote sites.

In some cases, it may be preferable, and reduce risk, if residual organic matter is stabilized and even sanitized prior to off-site discharge. For example, where the material needs to be manually carried from the site.

C- 1.8.3 ON-SITE DISCHARGE**C- 1.8.3.1 Stability, maturity and process records for on-site discharge**

The standards of this Manual use prescribed processes and performance indicators, together with testing, to determine suitability of residual organic matter for on-site discharge.

As shown by Figure C- 1 above, important performance indicators for residual organic matter are:

- Record of the process, including process monitoring data
- Stability of the material, including stability and maturity testing

For on-site surface discharge, additional testing for pathogen indicators and additional process documentation is necessary.

C- 1.8.3.1.(a) Record of process

The processes specified in this Manual are intended to result in specific outcomes (see the Appendix Section D-1). In order to confirm that these outcomes will be met it is important to monitor the process. The standards establish the factors that are to be monitored.

Third party oversight of this monitoring by an AP, as part of system maintenance, is required by the SSR and provides an additional safety factor.

C- 1.8.3.1.(b) Stability

Stability of compost refers to a specific stage of decomposition during composting. Highly stabilized compost will have low or no odor, will not attract vectors, will not tie up nutrients in soil and will not reduce oxygen availability if applied to soil.

Stability relates directly to the oxygen consumption and CO₂ evolution rates for the material. High oxygen consumption and high CO₂ evolution rate indicates the composting material is still actively decaying and is not stable. A reduced C:N ratio may also be an indicator of stability, for materials that began the composting process with a high C:N ratio.

Maturity refers to the agricultural or soil amendment value or impact of the residual organic matter. Typically, two or more parameters are evaluated to assess maturity. Maturity is affected by stability, and maturing usually occurs after stabilization. Maturity also represents the impact of compost chemical properties on plant development and soil organisms. For example, high levels of ammonia in immature material can impact seed germination or root development.

No single factor adequately represents stability and maturity. Common tests represent the two key areas of concern:

- Little or no further decomposition will occur, material is stabilized (respiration indicators, such as self-heating, oxygen uptake or CO₂ evolution).
- Not toxic or phytotoxic and low or no negative affect on plant growth (ammonia level, Germination Index, root elongation, earthworm bioassay).

For on-site discharge ammonia levels are also important due to the potential for environmental pollution by free ammonia.

The Canadian Council of Ministers of the Environment (CCME) has prepared Guidelines for Compost Quality (2005). The document provides guidelines for assessment of stability/maturity based on analytical testing, and specifies CAN/BNQ sampling and analytical methods for testing.

This is available at: http://www.ccme.ca/files/Resources/waste/compost_quality/compostgdlns_1340_e.pdf

As an alternative, the Solvita compost maturity test is specified by the standards. This test represents decomposition and stability by measurement of CO₂ evolution and phytotoxicity and maturity by measurement of ammonia.

When performing Solvita tests on composting toilet residual organic matter it is recommended that large particles (>10 mm) of bulking agent (if present) are sieved out, since their inclusion can cause inconsistent results. Ensure that the test sample is representative; do not collect a sample which is primarily bulking agent. Solvita is a live test, and so can give incorrect results if microbial activity is inhibited, for this reason it is important to follow test kit instructions for correct moisture conditioning. Because of inhibition by ammonia CO₂ evolution may be artificially low if the Solvita ammonia reading is 1 or 2, for this reason the standards specify stability testing prior to pH, urea or ammonia sanitizing.

For further information on stability and maturity, refer to "Compost Maturity Index." California Compost Quality Council, 2001. Available at: <http://www.calrecycle.ca.gov/organics/products/quality/compmaturity.pdf>

Information on Solvita testing may be found at: <http://solvita.com/compost>

When material has been sanitized using ammonia (from urea addition) then ammonia levels in the material will be high. For that reason, only stability is tested and testing is conducted prior to urea treatment.

The standards for testing mean that even where a batch sanitizing step (e.g. a thermophilic stage) is used and documented, curing will still be necessary in order to ensure the residual organic matter is stable and mature.

C- 1.8.3.2 On-site surface discharge of composting toilet residual organic matter

On-site surface discharge is defined, for the purposes of this Manual, as discharge to the surface of land or incorporation into the soil surface by mixing, injection or other method other than on-site burial meeting the standards of this Manual.

The BC *Environmental Management Act* specifies that a person must not introduce waste into the environment in such a manner or quantity as to cause pollution. The best practice guidelines of this section are intended to result, if applied, in prevention of pollution.

The guidelines of this Section apply **only** to on-site surface discharge of residual organic matter from composting toilet systems where:

- The composting toilet system receives excreta from residential use only, and
- The site has an SPM equivalent combined sewage DDF of 2400 L/day or less, and
- Standards and guidelines of this Manual are followed and applied, and
- Residual organic matter is discharged on-site, and
- No more than 5 m³ of residual organic matter is applied to the site in any one year.

The guidelines are intended to assist in management of process and materials to result in residual organic matter and discharge meeting the performance standards of this Manual (Appendix Section D- 1).

Table C- 3 provides process and quality guidelines for residual organic matter prior to on-site surface discharge.

Table C- 3. Residual organic matter quality for on-site surface discharge

Minimum quality	Collect at least 3 of 100 g samples per batch. Collect a sample from the bottom, middle and top of the batch. Meet the following standards: <ul style="list-style-type: none"> ○ No recognizable fecal material ○ Meet minimum stability and maturity standards, below ○ Maximum 75% w/w moisture (assessed by testing or estimation) ○ E. coli maximum 200 MPN per gram dry weight ○ No sharp foreign matter ○ Less than one piece of foreign matter greater than 25 mm in any dimension per 500 mL ○ C:N ratio less than 25:1 ○ Metal levels to meet T-4-93 specification, see note.
Minimum stability and maturity, using analytical test methods	Except for ash from an incineration process: <ul style="list-style-type: none"> ○ Test all samples following CAN/BNQ standards to meet CCME guidelines for maturity/stability ○ Except for residual organic matter sanitized using the urea method (Table B- 12), test all samples for ammonia content, to meet total ammonia N of <500 ppm (dry basis).
Minimum stability and maturity, using the Solvita test method	Except for ash from an incineration process: <ul style="list-style-type: none"> ○ Test the material to confirm an ammonia and CO₂ combined Solvita maturity index of 6 to 8 for any sample
Type of process, pathogen reduction	<ul style="list-style-type: none"> ○ Use a batch process or continuous process with batch process final step, with a batch sanitizing or disinfection step ○ Or incineration ○ Pathogen reduction may be based on thermophilic composting or other sanitizing or disinfection method meeting the standards of Section C- 1.7.6
Monitoring of process for each batch	<ul style="list-style-type: none"> ○ Owner and Authorized Person to record process monitoring, including temperatures or other measures of pathogen attenuation, and retention time ○ Report to be prepared for the owner by the AP for each batch
Monitoring of residual organic matter quality	<ul style="list-style-type: none"> ○ By or under the supervision of a professional AP ○ Prior to on-site surface discharge ○ An AP to prepare a report on the residual organic matter quality for the owner

Note: As an alternative to testing for metals content, the professional may use tabular values for metals content from Table C- 2, page 58, together with the characteristics of additives and the mass reduction achieved by composting to predict whether the residual organic matter will meet guidelines for metal contaminant levels.

Refer to T-4-93 - *Standards for Metals in Fertilizers and Supplements*, Agriculture and Agri-Food Canada, for metals levels and calculations, available online at:

<http://www.inspection.gc.ca/plants/fertilizers/trade-memoranda/t-4-93/eng/1305611387327/1305611547479>

Table C- 4 provides guidance on on-site surface discharge. Prepare an on-site surface discharge plan and retain on file. Include in the system maintenance plan the requirements for on-site surface discharge and defined procedures for management of on-site surface discharge.

Assess site and soil following SPM standards, and refer to Table B- 15 for guidance on selection of appropriate maximum soil loading rates.

Follow the standards of Section B- 1.9.1, page 40, when handling residual organic matter.

Restrict discharge to areas with or which will be used for; pasture grass, shrubs or tree crops or ornamental landscaping. Do not apply to areas that will be planted with annual or soft stemmed food crops, annual landscape plantings (e.g. herbaceous borders) or lawn. Restrict access from people and domestic animals for a minimum of 30 days after discharge. On-site surface discharge with incorporation is recommended as the preferred method. Incorporation reduces risk and increases benefits from the residual organic matter.

Table C- 4. On-site surface discharge of residual organic matter

Plan for on-site surface discharge	<ul style="list-style-type: none"> ○ Define the requirements for the plan in the system maintenance plan. ○ To be prepared by the AP for the owner for each batch ○ Include information noted below.
Monitoring of on-site surface discharge	<ul style="list-style-type: none"> ○ On-site surface discharge to be monitored by or under the supervision of a professional AP ○ Report to be prepared for the owner by the AP
Minimum horizontal separation for discharge location	<ul style="list-style-type: none"> ○ 30 m to fresh water or sea water or breakout ○ 30 m to a source of drinking water or a drinking water supply well ○ 30 m to property line ○ Other setbacks to meet SPM horizontal separations for dispersal areas
Soils at discharge location	<ul style="list-style-type: none"> ○ Soil of a type and permeability identified by the SPM as appropriate for demand dosed pressure distribution with vertical separation of 60 cm ○ Vertical separation 60 cm min., all seasons, below greatest incorporation depth.
Maximum soil loading rates for discharge area	<ul style="list-style-type: none"> ○ Select soil loading rate following SPM standards for Type 3 HLR ○ Residuals loading rate in moist $\text{kg/m}^2 = \text{Type 3 HLR (L/day/m}^2) \times 0.5$ ○ Minimum contour length of discharge 3 m
Discharge of material	<ul style="list-style-type: none"> ○ Comply with standards of Section C- 1.7.2 for hygiene and safety during handling ○ Install signage to indicate biohazard and to restrict access during the time defined in the on-site surface discharge plan ○ Record in the maintenance plan the rationale for loading rate and monitoring provisions needed to adjust the loading rate ○ Restrict discharge to weather conditions which will not result in pollution due to run off of leached nutrients from the residual organic matter

Minimum information to be included in the plan for on-site surface discharge:

- Process standards, material testing and records to meet, at minimum, Table C- 3
- Storage and leachate management provisions
- Site and soil evaluation report and plan for discharge site
- Procedures for on-site surface discharge, including loading rates, timing of discharge, restrictions to site access and use after each batch is discharged
- Calculation of nutrient balance and specified monitoring and management requirements to avoid nutrient contamination of the receiving environment or degradation of site soils
- Long term site management plan, with long term loading rates, performance objectives and any required soil and environmental testing

C- 1.8.3.3 On-site burial

On-site burial is the on-site below ground discharge of residual organic matter that has been processed to meet the standards of this Manual. Size the burial system based on measured bulk density for the material to be discharged.

Bulk density of residual organic matter varies widely depending on type of process and bulking agents. Typical bulk density for moist compost is in the range of 420 to 590 kg/m³ (at 40 to 60% moisture content). For vermicompost, bulk density may be as high at 800 kg/m³. Measure and calculate bulk density based on a representative, settled, sample of the moist residual organic matter. See the Appendix D- 2 for online calculator.

The following example demonstrates calculation of the "area of infiltrative surface" (AIS) and material depth for a 3 bedroom single family residence (with 4 occupants, per the examples in Sections C- 1.4.3.1 and C- 1.4.7).

This is a residential system with SPM DDF <2400 L/day, with a composting toilet system using bulking agents and discharging a total of 2.4 m³/year of residual organic matter (after processing). The system process includes a 1.5 year curing period, so material is discharged every 18 months.

Loading rate selection and calculation of AIS is based on the standards of Table B- 15.

Residual organic matter bulk density, measured, 500 kg/m³

6 month pile residual volume 1.2 m³, from example C- 1.4.7.6 on page 61

Mass of material for burial = volume x bulk density = 1.2 m³ x 500 kg/m³ = 600 kg

Selected SPM Type 2 HLR 40 L/day/m² based on soil type and Kfs

Residual organic matter loading rate = 3.5 x SPM HLR

= 3.5 x 40 L/day/m² = 140 kg/m²

Required AIS = mass ÷ loading rate

= 600 kg ÷ 140 kg/m² = 4.3 m²

SPM DDF < 2400 L/day, residential use. Minimum system contour length 3 m.

Minimum system width = AIS ÷ system length = 4.3 m² ÷ 3 m = 1.43 m.

Or, calculate minimum system length based on desired width of trench or bed:

For 0.9 m desired width

Minimum system length AIS ÷ system width = 4.3 m² ÷ 0.9 m = 4.8 m.

Calculate depth of material after settling to evaluate vertical separation:

Depth of material = loading rate ÷ bulk density

= 140 kg/m² ÷ 500 kg/m³ = 0.28 m

Minimum depth of cover follows standard, 0.15 m

Total depth from ground surface to base of trench = 0.28 + 0.15 = 0.43 m

Check vertical separation meets SPM standards for Type 2 HLR and a gravity distribution system.

Check horizontal separation meets SPM standards and the standards of Table B- 15

For material that has been sanitized using ammonia (from urea), consider the potential impact of the high ammonia levels. To reduce environmental risk, consider increasing contour length and increasing horizontal separation to fresh water. Lime application at time of burial will ensure adequate alkalinity is available for nitrification.

Only apply material during extended dry weather to reduce the risk of ammonia leaching from the residual organic matter before the soil bacteria have had time to nitrify the ammonia.

Specify in the maintenance plan that burial locations and dates are to be disclosed to new owners of the property.

C- 1.8.3.3.(a) Residual mulch media and cover mulch

Sizing, specification and installation for the on-site burial system is as for other residual organic matter.

C- 1.9 Maintenance guidelines

C- 1.9.1 HEALTH AND HYGIENE PRECAUTIONS DURING PROCESSING AND HANDLING

Composting toilet systems can produce residual organic matter which is mature, stable and has a very low pathogen content. However, even in the most favorable situations, there is still risk of pathogen contamination.

Follow Work Safe BC safety procedures as well as the hygiene standards of this Manual.

C- 1.9.2 MAINTENANCE

Maintenance and operation manages the system to meet composting toilet system primary purposes and any secondary objectives as defined by the system design (Section B- 1.3.1, page 28). The operation instructions and the maintenance plan are a critical part of the system, and are as essential to successful performance as the original selection and specification of the system.

Monitoring requirements and targets (e.g. target time at temperature, target moisture content) vary depending on the type of process and on the intended discharge method for residual organic matter. It is important that the maintenance plan clearly states the required process objectives. Particularly, how operation, monitoring and maintenance are specified to result in the system meeting those objectives.

Include specific monitoring requirements and performance objectives in the maintenance plan, together with procedures to follow in case of the system not meeting objectives (e.g. contact system planner).

Given the wide range of available technologies and processes this Manual does not provide details of recommended maintenance and operation procedures. When creating the maintenance plan and operation instructions, refer to the manufacturer guidelines or the guidance of the open source design manual for the selected composting toilet system and process.

When writing instructions for owners and maintenance providers present them in a simple point or tabular form. Preferably, use check lists or tables to help with documentation of the process.

C- 1.9.3 OWNER INVOLVEMENT IN OPERATION AND MAINTENANCE

The owner may be more involved in operation and maintenance of the composting toilet system than normal for a conventional sewerage system. Particularly, the owner will need to undertake operation and management of the system.

As with all sewerage systems, the composting toilet collection and composting systems should be specified and installed with maintenance in mind. Careful consideration should be given prior to specifying complex systems that require a high level of technical expertise or a larger time commitment from the owner.

See the Appendix D- 5 for examples illustrating typical operation tasks (performed by the owner) versus maintenance tasks or maintenance supervision (by the maintenance provider AP). Include in the maintenance plan a checklist for health and safety risk management to be used by the owner and by the maintenance provider. At minimum, address the following:

- Confined space risks (if any)
- Hygiene practices, including the standards of Section B- 1.9.1 for handling of materials
- Lifting and carrying procedures to avoid risk of injury

C- 2.3.2 OTHER DAILY DESIGN FLOWS**C- 2.3.2.1 Hand washing facility at public use site**

To estimate the number of uses per day for a hand washing facility, base calculations on the daily average use for the peak use week. The standard design flows include a peaking and safety factor of 2.

C- 2.3.2.2 Custom design flows

When selecting custom design flows the professional should consider organic, nutrient and pathogen mass loading to treatment and dispersal systems, and ensure that selected design flows are appropriate for use with selected loading rates.

C- 2.3.3 SOURCE SEPARATED STREAM FLOWS AND CHARACTERISTICS**C- 2.3.3.1 Urine**

Urine daily design flow may be reduced or increased based on urinal or diversion system performance.

In all cases add to the urine daily design flow 2 times the estimated average daily volume of any flush or wash water discharged to the urine collection system. The factor of 2 provides the peaking and safety factor.

Performance of urine diversion or separation systems is typically in the range of 50 to 95% urine diverted. Waterless urinals improve diversion efficiency.

Urine has a high concentration of nutrients and salts, and can be a source of valuable nutrients, see Section C-1.4.6, page 57, for typical constituent parameters.

Urine is diluted prior to application, and dilution is typically by mixing with greywater. Dilution is used to improve distribution of the nutrients, and to help avoid potential environmental impact from the high levels of nitrogen in urine.

Although excreted urine has low pathogen content, collected urine may be contaminated with fecal matter and is to be considered contaminated as for other wastewater and effluent streams.

C- 2.3.3.2 Leachate

Leachate flow volume may be reduced or increased based on the specified composting processor and collection system.

In all cases add to the leachate daily design flow 2 times the estimated average daily volume of any flush or wash water discharged to the composting processor. The factor of 2 provides the peaking and safety factor.

In some cases, or during part of the composting process, some or all of the leachate may evaporate. This is particularly the case during higher temperature composting and with mixing, or if leachate is recycled to add moisture to the compost.

Plan the leachate treatment and discharge system to accept the maximum predicted daily leachate volume.

Leachate quality is highly variable, typical leachate strength:

- cBOD₅ 350 mg/L
- TSS 140 mg/L
- Total Nitrogen as N 200 mg/L

In general leachate quality may be expected to improve as the compost pile matures in a processor. Conservative design values and testing representing early stage development are recommended.

Estimation of minimum flush volume discharged to a composting processor where micro flush toilets or other wash down water is used should be based on manufacturer volume per use data. Typical residential toilet usage results in 35 flushes per person per week, or average 5 flushes per day. Where urinals are provided flushes will be reduced. Where all occupants are in the residence full time, flushes may be increased.

For some open container systems, it is necessary to consider rainfall input when estimating leachate daily design flow.

C- 2.3.3.3 Blackwater and brownwater

Where greywater streams are separated, it is necessary to consider appropriate treatment and discharge system selection and sizing for the blackwater. As blackwater is higher strength than combined sewage, modified septic tank sizing and dispersal system sizing standards are specified.

The strength of blackwater may vary widely, depending on type of water closet and type of collection system. The standards of this Manual are based on typical North American water closets and normal water-borne collection systems. If lower flows are expected, do not reduce tank or dispersal area sizing since mass loading will remain constant.

Typical blackwater strength (consistent with design values for excreta and blackwater design flows in this Manual):

- cBOD₅ 400 mg/L
- TSS 600 mg/L
- Total nitrogen as N 250 mg/L

Blackwater BOD levels are similar to those for combined residential sewage, but TSS values are close to three times those for combined residential sewage.

Brownwater is similar in BOD and TSS characteristics, but has a considerably lower nitrogen level (approximately 25 mg/L).

Blackwater and brownwater temperatures will be low, which will affect treatment systems receiving only blackwater or brownwater, or water separated from these streams.

C- 2.3.3.4 Water separated from blackwater

If effluent is separated from blackwater or brownwater using a centrifugal or filter process, effluent characteristics will be dependent on the efficiency of separation. The shorter the pipe run from the water closet to the separator, the more fecal matter is removed. It is recommended that feces do not remain mixed with water for more than a minute, and direct discharge from the water closet to separator via a short pipe section is preferred. Follow manufacturer guidelines for piping installation when pre plumbing for a centrifugal separator.

For favorable conditions, separators will remove 70-80% of fecal BOD and nutrients, but little to none of the BOD and nutrients contributed by urine.

Separated water will have low temperature, as for blackwater or brownwater, so there will be similar effect on treatment systems.

C- 2.3.3.5 Greywater

Greywater strength is highly variable. Table C- 5 summarizes literature values for constituents of greywater based on normal water usage. If less water is used, concentration of constituents in greywater will increase. For this reason, greywater daily design flows are not reduced based on water conservation.

Table C- 5. Typical and average parameters for greywaters

PARAMETER	COMBINED GREYWATER		LIGHT GREYWATER		DARK GREYWATER	
	RANGE	TYPICAL VALUE	RANGE	TYPICAL VALUE	RANGE	TYPICAL VALUE
cBOD ₅ (mg/L)	40 - 360	290	80 - 200	200	1040 - 1460	1200
TSS (mg/L)	7 - 550	250	40 - 280	150	235 - 1250	750
Oil and Grease (mg/L)	33 - 193	50		22		275
Total Nitrogen (mg/L)	0.5 - 15	10	2 - 5	2		50

Dark greywater will have considerably higher strength if a garburator is used or larger than normal amount of food waste is discharged to the kitchen sink. Source control is important and the use of garburators with greywater systems is not recommended.

If practical, it is recommended that dark greywater flows be combined with blackwater or brownwater. Removing this high strength, low volume, wastewater stream from greywater will reduce issues with the greywater system. Addition of dark greywater to blackwater or brownwater will improve septic tank treatment of dark greywater and will also help to increase the temperature and pH of the blackwater or brownwater stream.

Laundry greywater is slightly higher strength than very light greywater and carries a higher pathogen load. Synthetic lint particles in laundry greywater are not biodegradable and may accumulate in dispersal systems.

C- 2.4 Collection and treatment guidelines

C- 2.4.1 INTRODUCTION

The standards for collection and treatment systems include a wider range of options than for combined sewage systems.

For some sites (particularly for buildings without a water supply), collection of leachate or urine may use containers which are conveyed to the treatment and or discharge point. Greywater, blackwater and brownwater collection systems utilize sanitary drainage plumbing meeting the BC Plumbing Code.

C- 2.4.2 URINE COLLECTION AND STORAGE SYSTEMS

Solids and salts will precipitate from urine during collection and storage. It is important to provide good access for cleaning of collection piping, waterless urinal odor trap systems and storage vessels. Lay piping at adequate grade (1% or greater) and ensure there are no places where sediment can build up. Allow for jetting or other cleaning of lines, 3" sanitary drainage piping is preferable.

Urine forms corrosive compounds, ensure no metal components are used in the urine collection or storage systems. This includes replacing any copper sanitary drainage pipe in the building.

A septic tank is not needed for a urine system.

C- 2.4.2.1 Urine storage for seasonal dispersal

For seasonal irrigation use urine is stored. Urine is sanitized during storage in a sealed container, due to the production of ammonia. Urine is not diluted prior to storage because this will reduce the sanitizing effect of ammonia in the urine. Extending the inlet pipe to the base of the storage container prevents spraying of urine, mass flow of air to the collection piping and reduces ammonia loss through diffusion and mass air flow.

Storage tanks (other than bladder tanks) need to be pressure equalized. This may be by a small diameter vent pipe, vents with check valves or other method that reduces the risk of ammonia loss and controls odor.

For sites where no diversion to an all season system is available, calculate storage volume per storage container as minimum 0.7 x annual urine volume. Select annual or seasonal urine volume based on estimated average daily urine volume for the planned site use, following the standards of Section B- 1.4, page 29.

C- 2.4.3 DIVERSION COLLECTION SYSTEMS**C- 2.4.3.1 Diversion system options**

Wastewater streams may be diverted for a number of reasons, and these reasons are primarily based on the chosen dispersal or sub-irrigation method. Diversion systems include:

- All season diversion of a greywater stream
 - For example, light greywater diverted, treated and dispersed separately from dark greywater and blackwater flows. The treated greywater may be dispersed by a single, all season, dispersal system or may be dispersed by a sub-irrigation system in the summer and to a separate system in the winter.
- Seasonal diversion systems, where light greywater or parts of the light greywater stream are optionally diverted during parts of the year for sub-irrigation purposes. Seasonal diversion systems are divided to:
 - Mulch basin systems (meeting usage and flow limit standards)
 - Other seasonal diversion systems
- Urine (from urinals or urine diverting toilets) diverted alone or together with other wastewater
- Leachate diverted alone or together with other wastewater

C- 2.4.3.2 Filter systems

For mulch basin systems where light greywater is to be applied without the use of a septic tank, a lint filter for the washing machine and hair screens for bathtubs, showers and wash basins are recommended. The lint filter system should allow hygienic cleaning without the operator being exposed to aerosols or other risks.

The use of non-pressurized filter systems where water is retained in the filter or filter basin is not allowed, since biofilm growth will occur in the filter resulting in health risk as well as reliability issues.

C- 2.4.3.3 Seasonal diversion valves and plumbing

Diversion valves are typically three-way plastic ball valves. A combination of two-way ball or sliding gate valves may also be used, but are less desirable due to the risk of retaining greywater. Install the valve or valves using unions or specify a valve that can be disassembled in place to allow for easy maintenance.

When installing diversion valves, consider the risk of blackwater or other non-light greywater streams backing up into the light greywater collection plumbing. If practical the blackwater plumbing should exit the building in a separate pipe from the all season greywater stream(s), allowing safe diversion of one or more greywater streams from the all season greywater plumbing.

If there is a risk of sewage backing up into greywater plumbing from combined sanitary drainage plumbing or from a septic tank connection, consider installing a backwater valve on the greywater line prior to the septic tank or plumbing connection. Ensure backwater valves are accessible for cleaning and servicing.

C- 2.4.3.4 Surge capacity in the collection system for mulch basin systems

If the diversion system flows to sub-irrigation by gravity (e.g. branched drains to mulch basins), or is discharged to sub-irrigation by an appliance pump (e.g. washing machine pump to mulch basins) no surge capacity is needed in the collection system.

If diverted greywater is pumped to the mulch basins, size and install a surge tank following SPM pump chamber sizing standards and guidelines. Ensure that the surge tank empties as completely as practical when dosed, and does not hold significant water volume for more than 12 – 24 hours.

For a mulch basin system needing more than 24 hour surge capacity in the collection system, specify a septic tank system.

C- 2.4.3.5 Surge capacity for septic tank systems

If a septic tank is specified, the pump chamber follows the septic tank. The pump chamber is specified and installed as for a normal sewerage system pump chamber, with no concern over stored effluent.

C- 2.4.4 SEPTIC TANK SYSTEMS

C- 2.4.4.1 Septic tanks

Septic tank sizing for source separated wastewater streams is based on the SPM equivalent combined wastewater septic tank size, multiplied by an adjustment factor.

In all cases where a septic tank is specified a longer retention time will improve tank performance. In particular, pathogen removal performance for greywater septic tanks is improved by a retention time of 7 days or more at average flows.

For systems which with low design flow it is recommended that tank selection be based primarily on favorable tank shape rather than on volume. This will result in a tank with larger than minimum working volume.

Preferred tank geometry:

- Long and narrow, with a L:W ratio of 2 or greater
- Shallow, with a working depth of less than 100 cm
- Effluent filter inlet at 65 to 75% of working depth

For laundry greywater an effluent filter with smaller filter screen size is preferred, to assist with lint removal.

For dark greywater septic tanks, to improve grease removal performance, specify:

- A single compartment tank
- A short inlet pipe at 0.4 x working depth below inlet invert
- A low level intake to the effluent filter at 0.85 x working depth below outlet invert

Effluent filter alarms are recommended in all cases.

For seasonal diversion septic tanks, the inlet can be configured to allow overflow to an all season system in case of effluent filter plugging. Specify an effluent filter alarm to give indication that overflow is occurring.

C- 2.4.4.2 Example of septic tank sizing calculation

3 bedroom house, 225 m² living area. No garburator.

Select septic tank minimum working volume for combined greywater and for blackwater wastewater streams.

From SPM Table II-8, DDF 1300 L/day. This is the SPM equivalent DDF

SPM combined sewage minimum septic tank working volume = 3 x SPM DDF

= 3 x 1300 = 3900 L

For combined greywater, adjustment factor from Table B- 21 = 0.4

Combined greywater septic tank min. working vol. = SPM tank size x Factor from Table B- 21

= 3900 L x 0.4

= 1560 L

Check this is greater than minimum from Table B- 21 (800 L)

For blackwater, adjustment factor from Table B- 21 = 0.8

Blackwater septic tank minimum working vol. = SPM tank size x Factor from Table B- 21

= 3900 L x 0.8

= 3120 L

C- 2.4.5 TYPE 2 AND 3 TREATMENT SYSTEMS

Select an appropriate treatment system following SPM procedure standards. Select a system to reliably produce the specified effluent type when receiving the particular source separated wastewater stream.

C- 2.4.5.1 Greywater

Greywater or greywater septic tank effluent differs from normal residential sewage or Type 1 effluent in ways that affect selection of a Type 2 or 3 treatment method. Key factors include:

- Greywater suspended solids are typically smaller in size than those in domestic sewage, and settleable COD (chemical oxygen demand) or BOD (biochemical oxygen demand) is considerably lower. COD suspended solids/COD total ratio is 0.58 to 0.7 for domestic wastewater, and approximately 0.24 for combined greywater.
- Primary treatment (septic tank) removes less of the COD and BOD for most low strength wastewater streams than is the case for combined sewage.
- Greywater is lower in macro nutrients, including Nitrogen and Phosphorous. Domestic wastewater has a typical BOD:N:P ratio of about 100:20:5 whereas greywater typically has a ratio of 100:4:1. The optimum ratio for heterotrophic growth is 100:5:1. Therefore biological treatment of greywater without the addition of nutrients is possible but package treatment plants designed for domestic sewage or Type 1 effluent treatment may not perform as intended.
- Greywater BOD breaks down more rapidly than sewage BOD, resulting in higher oxygen demand in the first two days.

- Greywater suspended solids contain lesser proportion (approx. 33%) of slowly biodegradable or inert materials in comparison to Type 1 effluent (approx. 50%).
- Flow and strength variation in greywater may be wider than in domestic sewage.
- The temperature of some source separated streams may be low.

Greywater has been treated successfully with a wide range of techniques. In general, treatment systems that include biofilm treatment are preferred. The following technologies are commonly used for small scale greywater treatment:

- Attached growth
- Trickling filters
- Sand and other media filters
- Constructed wetlands
- Membrane Bioreactors

C- 2.4.5.2 Blackwater, brownwater and leachate

For selection of treatment systems, the temperature of the wastewater must be considered. Blackwater, brownwater and leachate will have lower temperatures than combined sewage.

For source separated wastewater streams with nitrogen levels higher than normal for residential sewage (e.g. blackwater) the wastewater may not contain enough alkalinity to allow nitrification in typical aerobic treatment systems. The selection and specification of aerobic treatment systems should take this into consideration.

C- 2.5 Effluent dispersal and sub-irrigation guidelines

C- 2.5.1 HYDRAULIC LOADING RATES

C- 2.5.1.1 Effluent strength and daily design flow

SPM standard Type 1 effluent hydraulic loading rates (HLR) are adjusted to address differing characteristics of particular source separated streams and their septic tank effluent. Do not adjust Type 2 and 3 HLR.

C- 2.5.1.2 Hydraulic loading rate adjustment example

<p>Residence, SPM equivalent combined sewage DDF 1300 L/day</p> <p>Owner wants an all season combined greywater system plus a seasonal diversion system to allow sub irrigation of some nut trees.</p> <p><u>For seasonal light greywater diversion system dispersal area:</u></p> <p>Adjusted daily design flow for light greywater 845 L/day (see Section C- 2.3.1.1)</p> <p>SPM DDF < 2400 L/day, residential use. Direct application of light greywater seasonally diverted for irrigation purposes is OK ("mulch basin system" meets Section B- 2.5.1.2 standards).</p> <p>Soil Loamy Fine Sand, Favorable structure and consistence category, Kfs 750 mm/day</p> <p>From SPM Table II-22 and II-23 native soil selected Type 1 HLR 27 L/day/m²</p>
--

For light greywater seasonal diversion system the HLR adjustment factor from Table B- 23 = 1.5

$$\text{Adjusted HLR} = \text{SPM HLR} \times 1.5 = 27 \text{ L/day/m}^2 \times 1.5 = 40.5 \text{ L/day/m}^2$$

$$\text{AIS} = 845 \text{ L/day} \div 40.5 \text{ L/day/m}^2 = 20.9 \text{ m}^2$$

For an all season dispersal area for combined greywater septic tank effluent for same site:

Adjusted daily design flow for combined greywater 910 L/day

For combined greywater effluent system the HLR adjustment factor from Table B- 23 = 1

$$\text{Adjusted HLR} = \text{SPM HLR} \times 1 = 27 \text{ L/day/m}^2 \times 1 = 27 \text{ L/day/m}^2$$

$$\text{AIS} = 910 \text{ L/day} \div 27 \text{ L/day/m}^2 = 33.7 \text{ m}^2$$

This area is needed in addition to the light greywater seasonal diversion system area.

If the house already had a functional on-site sewerage system then only the seasonal diversion sub irrigation system would need to be constructed, and the existing sewerage system could be used as the all season system.

C- 2.5.2 MULCH BASIN SYSTEMS

The standards provide mulch basin systems as an option for dispersal and sub irrigation in specific cases:

- Small, residential seasonal diversion systems using untreated light greywater and or urine
- Public use or larger residential systems that seasonally discharge stored urine diluted with fresh water

Mulch basin systems provide easy access to the infiltrative surface for maintenance and provide a favorable environment for the macro fauna which assist in maintenance of the infiltrative surface.

See Section C- 2.5.4, page 95 for guidance on urine dispersal systems and fertigation (fertilizing using an irrigation system). See Section C- 2.5.3.3, page 94 for guidance on irrigation.

Figure C- 2 shows a section of a typical mulch basin system. Effluent is dispersed to the surface of the mulch media and undergoes treatment in the mulch before reaching the native soil below. Two loading rates are used, one for the mulch media and the other for the basal soils—similar to the approach for sand mound systems. In plan mulch basins are typically circular or oval, but may also be constructed as a bed system.

For further information and guidance on mulch basin systems and branched drain distribution see:

A. Ludwig, *Create an oasis with greywater: your complete guide to choosing, building, and using greywater systems*. Oasis Design, 2000.

When referring to this book, follow the standards and guidelines of this Manual and the SPM where they differ from those in the book.

A chamber system with soil or sand infiltrative surface and covered by mulch is an option for all season or seasonal diversion systems, but is not a mulch basin system.

Figure C- 2. Schematic section of a typical mulch basin

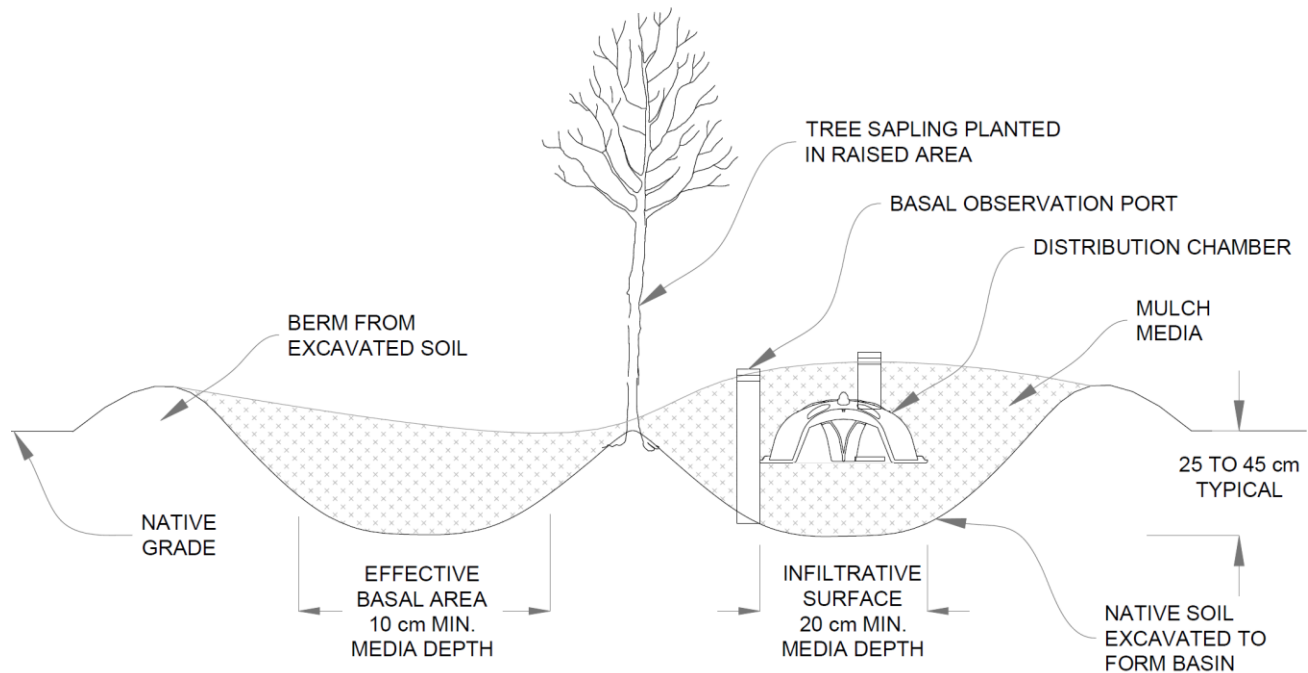

C- 2.5.2.2 Mulch basin hydraulic loading rate example

For the same example as in Section C- 2.5.1.2, page 89.

Residence, SPM equivalent combined sewage DDF 1300 L/day

For mulch basin sub irrigation of individual nut trees using seasonally diverted light greywater.

Mulch to be of a type identified as "favorable" (Section B- 2.5.1.2)

Soil Loamy Fine Sand, Favorable structure and consistence category, Kfs 750 mm/day

For mulch basin basal area use SPM Type 2 HLR (Section B- 2.5.1.2)

From SPM Table II-22 and II-23 selected Type 2 HLR 50 L/day/m²

Mulch basin soil basal area AIS = 845 L/day ÷ 50 L/day/m² = 16.9 m²

For a favorable mulch infiltrative surface HLR maximum 450 L/day/m² (B- 2.5.2.2)

Mulch basin mulch infiltrative surface min. AIS = 845 L/day ÷ 450 L/day/m² = 1.88 m².

The minimum required basal area could be provided by several mulch basins, with the minimum number of basins specified based on the irrigation demand estimated for the nut trees. This may result in a final basal loading rate that is lower than the maximum. See Section C- 2.5.3.3, page 94, for irrigation information.

If a sand blinding layer is used below the mulch media, base basal area on HLR for the native soil, not the sand.

C- 2.5.2.3 Mulch basin systems specification and installation guidelines

C- 2.5.2.3.(a) Mulch basin installation

Basins can be built up (with the berms raised above the original grade), or dug in to the native soil. Typically, an island or berm is left for planting the tree or shrub that is to be irrigated, and mulch media is used to fill the basin. Effluent is distributed to the media using a chamber system, covered by more media.

The preferred technique depends on available soil depth, slope, type of plant and other factors. Where winter rainfall is high, ensure a berm diverts up slope run on away from the basin. If a mulch basin is built up, particularly on a steep slope, ensure effluent will not break out on the downslope side of the basin berm. Refer to the SPM section III-5.4.4 for guidance on breakout risk.

It is recommended that media depth exceeding standards is installed to allow for settling and decomposition.

The pipe that discharges effluent into the chamber should be accessible for cleaning and to observe flow (allowing a check on flow splitting). Protect the media below the pipe exit from erosion by a splash plate or block.

For sites where reduction of vertical separation to a water table due to water table mounding may be a concern during the irrigation season, install observation standpipes following SPM Section III-6.5.2.3 guidelines.

C- 2.5.2.3.(b) Branched drain distribution

Branched drains provide a method of splitting flows in a dosed or trickling gravity distribution system. A series of double ¼ bend (double ell) DWV fittings are used with PVC DWV or ABS drain line to split flows. Each splitter is provided with a threaded plug, allowing access for testing and cleaning. Pipe size should be 1-1/4" nominal or larger. Figure C- 3 illustrates a typical splitter.

Figure C- 3. Branched drain system flow splitter (plan view)

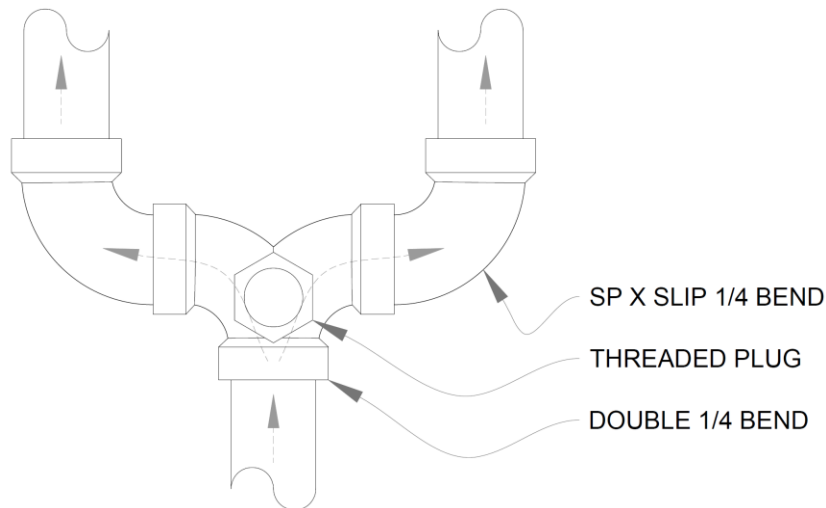

The system is installed to ensure all water drains out of the piping system in order to reduce the risk of biofilm formation. Typically splitting is limited to a maximum of 16 outlets (4 levels of splitting). Dosing will improve splitting. A branched drain system may be used to split flows after initial flow splitting by a tipping D-box or pressure manifold.

Branched drain distribution may be used with untreated light greywater, diluted urine or with any treated effluent, for mulch basin or sewerage systems. Branched drain systems are considered to be gravity distribution.

C- 2.5.2.3.(c) Media

When selecting media for mulch basins, consider the following desirable features:

- Resistant to degradation
- Open graded, with low uniformity coefficient and low fines content to improve air and water permeability and reduce risk of compaction over time
- Moderate particle size to provide improved effluent treatment
- Suitable for use as soil amendment
- Wettable (in some cases a wetting agent can be used to treat mulch)
- Dense enough to resist wind (if necessary consider using coarser mulch at the surface of the cover mulch)

Of the specified materials, bio-char and charcoal will last considerably longer than bark or wood chips. Formed clay trickling filter media will last indefinitely. Longer lasting media below the infiltrative surface will reduce maintenance.

The standards specify a minimum hydraulic conductivity for the media, after settling. This target should be met for the life of the media, that is, until the media needs to be renewed or replaced at the infiltrative surface.

Media may be used to cover chambers in all season systems. For all season cold climate applications, increase cover depth to minimum 30 cm settled depth over the chamber and minimum 60 cm horizontally to the edge of cover from the chamber to reduce risk of freezing.

For urine dispersal systems, addition of lime to the mulch basin media may be helpful in providing alkalinity for nitrification.

C- 2.5.2.3.(d) Infiltrative surface and basal area

Easy access to the infiltrative surface is important to allow maintenance. Maintenance may include renewal of mulch, mixing of mulch or moving the infiltrative surface to another part of the mulch basin. If relocation of the surface is anticipated, provide flexible piping or hose connection.

The basal area ratio standard results in a need to increase media infiltrative surface for mulch basins on low permeability soils (or to increase the number of mulch basins), the ratio is specified to address oxygen transport to the basal area soils. Scarify the basal area prior to addition of mulch.

C- 2.5.2.3.(e) Management of mulch media and mulch cover from chamber systems

See Section C- 2.6.3 for guidance on mulch media management. When planning, choose and specify a method for management of any residual media that is to be removed during maintenance.

Where trickling filter media is used and is mixed with organic mulch media, specify a management method that includes removal of the filter media prior to on-site burial (or specify off-site discharge).

C- 2.5.3 ALL SEASON DISPERSAL SYSTEMS AND SEASONAL SUB IRRIGATION SYSTEMS

Source separated wastewater dispersal systems use the modified daily design flow and HLR standards of this Manual with SPM standards for dispersal systems.

Mulch cover may be used on chamber systems. The dispersal systems may be planned to attain secondary objectives, such as nutrient recycling or sub irrigation.

See Section C- 2.5.4, page 95 for specific guidance on urine dispersal systems.

C- 2.5.3.1 Seasonal sub irrigation dispersal systems

For source separated wastewater dispersal areas that are to be used only during the irrigation season:

- Assess depth of soil to the limiting layer based on evaluation during the irrigation season
- Assess horizontal separation based on evaluation during the irrigation season
- Consider irrigation and fertigation requirements when establishing dispersal area size

C- 2.5.3.2 Options for sub irrigation

Standard sewerage system dispersal techniques can be adapted to provide sub-irrigation and or fertigation benefits.

The all season system may be specified with this purpose in mind, or a separate seasonal sub irrigation dispersal system may be specified, with seasonal switching between the summer and winter areas.

Subsurface drip dispersal (SDD) systems are well suited to installation to meet sub-irrigation needs. Consider the option of providing zones for landscape or turf irrigation, used in the dry season, and "winter" zones for discharge or fertigation in forested areas. Do not use SDD systems for dispersal of untreated greywater.

Sand lined bed or bottomless sand filter techniques may be adapted to provide planter beds with sub irrigation.

In some cases, the all season system may be planned for addition of fresh water to provide supplemental irrigation. This may result in higher HLR and LLR during irrigation. This approach is allowable as long as:

- Resulting HLR is no greater than SPM standard Type 2 HLR for the soil or sand media
- Vertical separation is based on Type 2 HLR vertical separation standards of the SPM
- Flow monitoring is used to confirm and monitor loading rate
- Moisture monitoring is used to avoid saturated conditions or a ponded infiltrative surface
- Vertical separation observation ports are in place and are monitored during the irrigation season
- Appropriate measures (e.g. testable backflow preventers, air gap), meeting the BC Plumbing Code, are taken to avoid cross contamination

For source separated wastewater streams with nitrogen levels higher than normal for residential sewage (e.g. blackwater or urine) effluent may not contain enough alkalinity to allow nitrification in the soil treatment system at standard HLR. Addition of lime or greywater to the dispersal system may be needed to prevent acidification of the soil and to improve nitrification performance.

C- 2.5.3.3 Irrigation

Irrigation demand varies with location (climate), type of plant, soil characteristics and season. The BC Ministry of Agriculture provides information and guidance on irrigation in BC, and the Irrigation Industry Association of BC provides manuals, guidance documents and online scheduling calculators for landscape and agricultural irrigation:

- <http://www2.gov.bc.ca/gov/content/industry/agriculture-seafood/agricultural-land-and-environment/water/publications>
- <https://www.irrigationbc.com/>

When planning a sub-irrigation dispersal system, the required minimum AIS must be met, but in addition irrigation demand needs to be considered.

For example, a typical 3 bedroom house light greywater flow could irrigate 20 to 80 m² (depending on plant species and stage of growth) to meet dry season demand. At a light greywater daily design flow of 820 L/day and with a HLR of 40.5 L/day/m², minimum soil AIS for this use would be 20 m². Depending on calculated demand it may be preferable to install additional dispersal area to provide a larger irrigated area (at a lower HLR), rather than having to divert part of the light greywater away from the sub-irrigation system.

Since greywater contains pathogens and nutrients soil based treatment is needed. When planning and managing irrigation, it is important to avoid saturation of soils below the sub-irrigation dispersal system. Install observation standpipes to allow monitoring of vertical separation if considered necessary. See SPM section III-6.5.2.5 for guidance on installation of observation standpipes. Include in the maintenance plan guidance on irrigation scheduling and references for the owner to sources of information for specific plant irrigation requirements.

To reduce health risk and risk of damage to the dispersal system, install irrigation or dispersal systems in areas with or which will be used for; lawn or pasture grass, forest, shrub crops, tree crops or perennial ornamental landscaping.

C- 2.5.4 URINE DISPERSAL SYSTEMS

Urine is high in nutrients, particularly nitrogen and phosphorous. Ammonia and nitrate nitrogen have a potential to cause environmental pollution and health risk. Urine is also high in salts and application of undiluted urine at high loading rates may result in damage to plants, or long term salt accumulation and soil damage in drier climates.

Dilution and reduced HLR is specified to reduce risk from high nitrogen levels and BOD levels in urine. Where sodium accumulation is a critical concern, seasonal urine systems may not be suitable and a higher dilution rate may be needed.

When urine is diluted, additional precipitation of salts, including struvite, may occur (depending on water chemistry). Because of this it is important to provide for easy flushing and cleaning of distribution systems. For example, a pressure distribution system should use laterals large enough to permit jetting (typically 1.25" or larger and without 90 degree elbows).

C- 2.5.4.1 Seasonal urine dispersal systems

During the growing season urine which is diluted and applied sub surface to the root zone of actively growing plants can provide beneficial nutrients to those plants. This leads to reduced risk from nutrients leaching to the receiving environment, particularly where aerial parts of the plants are harvested and removed from the site.

Dilution with greywater is practical, particularly where greywater is being used for seasonal irrigation. The standards specify a minimum dilution ratio (1 urine: 10 parts fresh water or greywater). A higher dilution may be needed, depending on fertigation objectives.

C- 2.5.4.2 Nutrient balance and fertigation

Nutrient balance is considered by relating the urine application rate to the maximum safe nitrogen application rate for the soil and crop. Where nitrogen requirements are not calculated, as a guideline, limit application of urine to 1.5 L stored urine per square metre per growing season.

As a simple example, a lawn where grass clippings are removed may use approximately 18 g of Nitrogen per square metre over the year (primarily from March to November). Based on 11 g Nitrogen per capita day in Urine (total) and 80% urine diversion rate one person provides approximately 8.8 g/day Nitrogen in their Urine. Applied over an 8 month period this equates to approximately 2000 g Nitrogen, which could fertilize up to 117 square metres of lawn. For improved efficiency calculation should be based on soil and or plant testing, soil type, soil organic matter content and other factors.

Fertilizer application timing is important, in general fertilizer application is not useful once a crop is close to harvest and application typically stops at about $\frac{3}{4}$ of the time from sowing to harvest.

Local Ministry of Agriculture offices can provide assistance with nutrient balance calculations and fertilizer requirements. Also see the irrigation resources referenced in Section C- 2.5.3.2.

As specified in Section B- 2.5.1.2, fresh or stored urine may be added at minimum dilution of 10 parts light greywater to 1 part urine prior to discharge in a mulch basin system.

C- 2.6 Maintenance guidelines

Follow Work Safe BC safety precautions and health and hygiene precautions for sewage or Type 1 effluent when maintaining any source separated wastewater system.

C- 2.6.1 SOURCE CONTROL

Source control is of particular importance. The need for source control should be explained in detail to the owner.

During system maintenance source control should be checked by the maintenance provider. This provides opportunity for further education of the owner.

C- 2.6.1.1 Planting and irrigation

Specify in the maintenance plan that the irrigation area or dispersal area should not be planted with annual or soft stemmed food crops. Avoid plantings that require regular soil disturbance, such as annual herbaceous borders. Suitable plantings include grasses, tree and shrub food or biomass crops or perennial landscaping plantings. Identify suitable plantings and recommend planting maintenance procedures, including instructions for avoiding risk related to working with soil contaminated with pathogens.

Specify procedures for monitoring of vertical separation below seasonal irrigation systems if vertical separation is anticipated to be a constraint to irrigation rate.

C- 2.6.2 URINE COLLECTION SYSTEM AND STORAGE TANK

Although waterless urinals form part of the plumbing, rather than sewerage, system, include in the maintenance plan instructions for maintenance and cleaning of the urinal and urinal odor trap, following manufacturer guidelines. Specify regular inspection of the urine collection piping.

When emptying a urine storage tank, it is preferable to stir contents to suspend viscous sludge from base of the tank, or pump sludge out separately. The sludge may have higher pathogen risk, so take hygiene precautions when cleaning tanks.

To remove mineral and salt buildup from the tank and collection system components, soaking and scrubbing with acetic acid, hydrochloric or sulphuric acid will assist. A 5% solution of sulphuric acid, 20% solution of hydrochloric acid or 20 to 24% solution of acetic acid is suitable. Take appropriate safety precautions.

C- 2.6.3 MULCH MANAGEMENT**C- 2.6.3.1 Management of mulch media and cover mulch**

The majority of mulch media in basins or cover mulch on chamber systems is not removed during maintenance. The residue of decomposed mulch is combined with the soil below and on the edge of the basin or trench and additional mulch is added. Biochar and charcoal mulch or artificial media have a long lifespan and will seldom require replacement.

A mulch basin may also be expanded with time, particularly where a tree planted in or next to the basin grows. In that case older mulch may be spread to the new basin area and new mulch added to re-establish design depth of media.

However, it may be necessary to periodically remove some partially decomposed mulch from a mulch basin system and replace with fresh mulch. Roots may also be removed from the mulch basin chamber. Likewise, it may be necessary to periodically remove partially decomposed cover mulch from a chamber system.

When considering mulch basin infiltrative surface conditions and whether renewal is needed, mulch media permeability may be tested and should meet the minimum standards of Table B- 24.

Depth of media below the infiltrative surface should not be less than standards. It is recommended that a greater depth is installed when renewing media to allow for settling and decomposition.

Mulch that is removed from a mulch basin system or cover mulch removed from a chamber dispersal system will be contaminated with pathogens. For this reason, the residual spent mulch needs to either be discharged off-site, buried on-site or needs to be composted and treated as for composting toilet residual organic matter.

Mulch or other media removed from systems that do not meet the standards of this Manual, or for systems other than those specifically identified in Table B- 25, should be discharged off-site to an approved facility or managed under a site and project specific, performance based, plan developed by a professional and meeting appropriate regulatory requirements.

C- 2.6.3.2 Safe handling of mulch media and cover mulch

Mulch media should be identified as a potential biohazard in the maintenance plan. When maintaining mulch basin systems or chamber systems with mulch cover, APs and owners should follow health and hygiene standards for composting toilet system residual organic matter in Section B- 1.9.1 page 40.

C- 2.6.3.3 On-site burial of mulch media and cover mulch

Residual mulch meeting standards may be buried on-site without further processing. See Section B- 1.8.3.2 for on-site burial standards.

C- 2.6.3.3.(a) Composting of mulch media and cover mulch

Residual mulch may be combined with excreta or urine in a composting toilet system. Mulch may help to adjust composting process carbon to nitrogen (C:N) ratio. Co-composting with urine is a favorable option due to the high nitrogen content of urine.

Alternatively, the discarded mulch may be composted in a separate processor. Select, plan and specify the composting processor, process and discharge to meet composting toilet system composting processor standards and process standards for the proposed discharge method.

C- 2.6.4 OWNER INVOLVEMENT IN OPERATION AND MAINTENANCE

The owner may be more involved in operation and maintenance of the source separated wastewater system than their conventional sewerage system. For a seasonal diversion system, they will need to understand how and when to divert greywater, how to switch irrigation zones, diagnose issues with irrigation etc.

The owner will need to be familiar with safe operation and regular cleaning of any diversion device or screen. If the owner is to be involved in cleaning system components, the maintenance plan should include detailed instruction on safety precautions for the owner.

As with all sewerage systems, the collection, treatment and dispersal systems should be specified and installed with maintenance in mind. Careful consideration should be given prior to specifying complex systems that require a high level of technical expertise or a larger time commitment from the owner.

Include in the maintenance plan a checklist for health and safety risk management to be used by the owner and by the maintenance provider. At minimum, address the following:

- Potential health risks and hygiene practices, including for management of mulch basin systems (if applicable)
 - Cleaning procedures for effluent filters that reduce risk of health and environmental risk
 - Personal protective equipment and maintenance of equipment
 - Disinfection procedures for tools, equipment and containers
- Lifting and carrying procedures to avoid risk of injury

Part D Appendices

D- 1 PERFORMANCE OBJECTIVES AND RATIONALE

D- 1.1 Introduction

This Part is intended to be used for background information and reference. It states the performance basis for the standards of this Manual, and summarizes the rationale for key standards. The rationale does not repeat information or rationale presented in the BC SPM, and does not include rationale for commonly-used and well established methods or equipment such as septic tanks or effluent filters.

In this Part, technical terms are used and concepts mentioned which may not be familiar to the reader. Refer to Section D- 2 for a selection of manuals for further reading. Refer to the SPM for further information on rationale for sewerage system standards.

D- 1.2 Performance statements

The Sewerage System Regulation (SSR) provides a base performance statement, requiring that sewerage systems be constructed with the result of not causing or contributing to a health hazard.

A "health hazard" is defined as the discharge of domestic sewage or effluent into a source of drinking water, surface waters, tidal water, a sewerage system that is not capable of containing or treating domestic sewage, or onto land. A "health hazard" also includes the proposed construction or maintenance of a sewerage system which may, in the opinion of a Health Officer, cause a health hazard.

The BC Building and Plumbing Code (BCBC) identifies objectives for health protection. See Appendix D- 4 for further information.

This Manual is intended to:

- Provide system standards and guidelines that support cost effective health protection.
- Establish actions and standards commensurate with risk.
- Provide simple standards that are readily applied.
- Provide standards and guidelines that support environmental protection.
- Provide standards and guidelines supported by science, evidence or by evidence of best practice.

Given the emerging nature of technology in the field, standards were developed to meet the objective of allowing for as wide a range of options and techniques as practical, and allowing for future development and innovation.

D- 1.3 Performance objectives

D- 1.3.1 RISK OBJECTIVES

This manual adopts the following objectives to represent acceptable risk levels for infection and disease resulting from a composting toilet or source separated wastewater system. These objectives apply to normal use of the system by the owner or other users, and to risk to other individuals from discharge to the receiving environment.

- Design and specification of the system and components, and the system maintenance plan, are to provide a multiple barrier to microbial risk.

- Maximum tolerable additional DALY* loss of 10^{-6} per person per year for collection, treatment and re use systems. Correlates to drinking water supply system objectives.
- Maximum tolerable additional DALY* loss of 10^{-4} per person per year for ground discharge. Correlates to recreational water objectives. For norovirus, this DALY equates to:
 - Maximum tolerable additional risk of norovirus infection of 0.14 per person per year for ground discharge.
 - Maximum tolerable additional risk of norovirus disease of 0.11 per person per year for ground discharge.

These objectives are based on risk objectives and approach to risk management established by Health Canada and the WHO (Petterson and Ashbolt 2005; WHO 2006; Mara, Hamilton, Sleigh, and Karavarsamis 2010; Government of Canada 2010). Norovirus was selected as the primary reference viral pathogen for risk assessment relevant to ground discharge of human waste (Mara, Hamilton, Sleigh, and Karavarsamis 2010; Mara, Hamilton, Sleigh, Karavarsamis, et al. 2010; Kemmeren et al. 2006; Ottoson and Stenström 2003).

These objectives do not apply to risk to Maintenance Providers when servicing or repairing the system. For these situations the Manual recommends the application of Work Safe BC safety procedures as a risk management objective, and further specifies other barriers to risk for Maintenance Providers (including personal protective equipment standards and system specification standards related to maintenance access).

**DALY is the Disability Adjusted Life Year, the sum of years of life lost and years lived with disability, weighted for the severity of disability. Norovirus per person risk objectives are based on 9×10^{-4} DALY per person per year.*

D- 1.3.2 COMPOSTING TOILETS

This Manual adopts the performance objectives for protection of health established by the BC Building and Plumbing Code (2012), and expands them to the primary purposes for composting toilets stated in Section B-1.3.1.

Functional statements:

- Composting toilets and composting toilet installations are to provide facilities for personal hygiene.
- Composting toilets are to provide facilities for the sanitary collection, treatment and storage of human wastes (particularly urine and feces).

Composting toilets are to provide facilities for ground discharge of human wastes (particularly urine and feces), where residual organic matter meets standards.

Objective:

To limit the probability that, as a result of the design, construction, operation or maintenance of the composting toilet and ancillary components, a person inside or outside the building or facility will be exposed to an unacceptable risk of illness due to unsanitary conditions. The risks of illness due to unsanitary conditions addressed in this Manual are those caused by:

- Exposure to human or domestic waste
- Consumption of or contact with contaminated water
- Inadequate facilities for personal hygiene
- Contact with contaminated surfaces
- Contact with vermin and insects and vector transmission of disease from human waste or food waste

Planning, construction and maintenance of composting toilets and their components are specified to meet these objectives.

As part of a sewerage system, composting toilets and their components are required to be constructed and operated to avoid causing or creating a health hazard.

D- 1.3.3 COMPOSTING TOILET RESIDUAL ORGANIC MATTER

D- 1.3.3.1 For off-site discharge

Off-site discharge to an approved facility does not require any defined on-site performance objective for residual organic matter.

The Manual specifies adequate and safe access for removal, and safe handling. Standards are based on the objective that removal of residual organic matter be practical without creating a health hazard for equipment operators or site users that differs from risk when pumping a septic tank.

D- 1.3.3.2 For on-site subsurface discharge

Performance objectives for ground discharge of residual organic matter are the same as or equivalent to those used in development of BC SPM standards, see SPM Volume IV Rationale for statement of performance objectives and for further discussion.

Objective for pathogen removal performance at the limiting layer (at the base of the soil treatment unit) is to a median fecal coliform bacteria density of less than 200 CFU/100mL, to meet the BC Approved Water Quality Guideline for recreation, primary contact.

Standards and guidelines were developed for source separated wastewater sewerage systems which, when applied, result in compliance with the same performance objectives as the SPM.

D- 1.3.3.3 For on-site surface discharge

To address contact risk, a pathogen indicator objective for the residual organic matter prior to discharge is established as *E. coli* bacteria 200 MPN/g dry weight maximum in any of three samples of a batch. Recommended soil treatment performance objectives for on-site surface discharge of residual organic matter are as for on-site subsurface discharge.

D- 1.3.4 HAND HYGIENE

Objective for hand sanitizer to provide adequate hand hygiene when used in place of hand washing either:

- Minimum 2 Log₁₀ reduction after the first application and 3 Log₁₀ reduction after the tenth application of either *Serratia marcescens*, *Staphylococcus aureus* when tested following ASTM E2755–10
- Or, testing to meet European standard EN 1500 (BS EN 1500:2013) for reduction of *E. coli* release from skin not significantly inferior to a standardized 60% isopropanol test solution with 30 second application

This objective was based on Health Canada, WHO and U.S. FDA recommendations and review of literature (US FDA 1991; US FDA 2013; Health Canada, n.d.; E35 Committee 2010; CDC 2002; Pittet et al. 2009; NHMRC, n.d.; Maiwals 2009; Suchomel et al. 2012).

D- 1.3.5 SOURCE SEPARATED WASTEWATER SYSTEMS

Objectives for sewerage system performance used in development of standards for this Manual are the same as or equivalent to those used in development of BC SPM standards, see SPM Volume IV Rationale for statement of performance objectives and for further discussion.

Standards and guidelines were developed which, when applied, are expected to result in achievement of the same performance objectives as the SPM.

D- 1.3.5.1 Pathogen indicators and greywater effluent

Greywater streams differ in pathogen levels from sewage or Type 1 effluent. For development of standards Quantitative Microbiological Risk Analysis Monte Carlo simulation (QMRA) evaluation of greywater was based on consideration of norovirus risk, which is recommended for assessment of pathogen risk in greywater and sewage streams (Scheierling et al. 2010; Mara, Hamilton, Sleigh, and Karavarsamis 2010; Teunis et al. 2008; S Fiona Barker 2012; Rutjes et al. 2009).

Norovirus levels in greywater during an outbreak at a single family dwelling will be approximately 3.5 log₁₀ lower than for combined sewage, based on consideration of comparative fecal load (Ottoson and Stenström 2003; Atmar et al. 2008; Ottoson 2004; S Fiona Barker 2012). These reduced levels result in reduced risk for infection related to greywater in comparison to sewage.

Levels of common pathogen indicators (fecal coliform or E. coli bacteria) in greywater are lower than those in sewage, but not sufficiently lower to adequately address the lower pathogen risk from greywater.

For this reason, consideration of risk from greywater streams should be based on assessment of fecal contamination (or, for dark greywater, risk of contamination with salmonella or other food related pathogens).

Use of fecal coliform CFU counts as pathogen indicators for greywater streams have the following failings:

- Fecal coliform bacteria breed in greywater (Rose et al. 1991; Brandes 1978)
- Fecal coliform bacteria have been found to overestimate fecal contamination of greywater by up to 1000 times in comparison to chemical biomarkers (Ottoson and Stenström 2003)

Fecal coliform levels are therefore not a reliable indicator to use when attempting to gauge pathogen level in the greywater stream or in water flowing from a greywater soil treatment system.

Calculations of pathogen attenuation may be conceptually based on fecal coliform bacteria, as a method of comparing performance of soil based treatment for pathogen attenuation. This approach was used in preparation of standards for this Manual to compare performance of soil based treatment at varying loading rates for greywater effluents versus combined sewage Type 1 effluent, using the same procedure as used in development of the SPM soil treatment and dispersal system standards. This comparison is considered valid since removal rate of indicator organisms has been shown to reflect typical attenuation of infective viral particles in soil or sand media based treatment systems.

However, for monitoring of fecal contamination of greywater streams and assessment of pathogen levels, where an indicator organism is needed, it is recommended that fecal enterococci be used.

The SPM soil treatment unit performance objectives are based on indicator removal to a median fecal coliform bacteria density of less than 200 CFU/100mL, to meet the BC Approved Water Quality Guideline for recreation, primary contact. An appropriate equivalent level of fecal enterococci, for monitoring purposes, is median less than 35/100 mL (Health Canada 2012).

D- 1.3.5.2 Objectives for pathogen removal performance in the soil treatment unit

For this Manual, the primary water quality objectives, at the limiting layer, were based on fecal enterococci indicator bacteria, as follows:

- Removal to a median fecal enterococci bacteria density of less than 35 CFU/100mL
- Similar bacteria removal at the limiting layer for all dispersal techniques, loading rates and effluent types.

For the practical purpose of monitoring of groundwater quality, these water quality objectives can also be considered to apply to groundwater sampled at a distance of 4 metres down-gradient from the lowest edge of the dispersal system. This distance is established to represent a distance far enough from the dispersal field to avoid accidental damage (over 3 m), and close enough that water sampled will be reasonably representative of the water quality at the limiting layer below the dispersal area.

D- 1.4 Rationale for standards**D- 1.4.1 COMPOSTING TOILETS****D- 1.4.1.1 Excreta characteristics**

Excreta (feces and urine) characteristics vary widely and are strongly affected by diet (Håkan Jönsson et al. 2004a). For this Manual adopted values were selected from literature values, with higher weighting given to studies representative of European and North American diet and cool climate conditions (Gotass 1956; R. G. Feachem et al. 1983; Porto and Steinfeld 2000; Vinnerås 2002a; Crockett 2003; Håkan Jönsson et al. 2004a; Palmquist 2004; Münch, n.d.; H. Jönsson et al. 2005; Oldenburg et al. 2008; Eran Friedler, Butler, and Alfiya 2013).

D- 1.4.1.2 Accumulation volume

This Manual does not provide generic accumulation volume standards. This is due to the widely varying nature of composting toilet systems and processes, and to the technology, site and project specific nature of accumulation rates.

Guidance is provided to support the AP in documenting rationale for selected accumulation rates.

D- 1.4.1.3 Selection

Selection standards were developed to support defined primary objectives for composting toilet systems, which were in turn developed to meet the performance objectives of this Manual and the BCBC.

NSF 41, CSA/NSF 41 and other standard testing is available for composting toilets (AS/NZS 2008). However, given the wide range of available open source designs available and the need to base selection on site and project specific considerations, testing was not specified as a primary method for system selection. This approach is similar to that followed in the SPM for sewage treatment systems.

D- 1.4.1.4 Incinerating toilets

The design of incinerators and incinerating toilets is planned to result in a sterile ash end product. However, there is evidence that incinerators (large incinerators or small single toilet units) may in some cases not fully burn waste, or may leave unburnt material that can post contaminate residual ash (Ware 1980; USEPA 1999). For this reason, on-site surface discharge of residual ash is not considered safe and standards of this Manual mandate monitoring of the process and residual material prior to off-site discharge or on-site burial.

Carbon content standard for ash was based on Schönning and Stenström (C. Schönning and Stenström 2004).

D- 1.4.1.5 Partial disinfection or sanitizing

Time at temperature relationships for pathogen attenuation were based on literature values and review of regulatory provisions including Canadian, Australian/New Zealand and European standards (R. G. Feachem et al. 1983; CCME 2005; CCME 2010; Hogg et al. 2002; NRC (US) 2002; Elving 2009). Considerations included the risk of sub-standard management of the composting process, for example uneven heating of material during thermophilic composting (Elving 2009).

Pasteurization time and temperature standards were based on review of regulatory provisions and literature, including consideration of virus inactivation (Hogg et al. 2002; Emmoth 2010; Sahlström 2006).

For ammonia and combined pH/ammonia based sanitizing systems a >4 log₁₀ reduction is predicted for pathogens, including helminth ova (Nordin 2010; Emmoth 2010; Caroline Schönning 2003; Niwagaba and Makerere University. 2009).

pH adjustment standards consider research related specifically to human waste and manure (C. Schönning and Stenström 2004; Caroline Schönning 2003; Håkan Jönsson et al. 2004b).

D- 1.4.2 COMPOSTING TOILET PROCESSORS AND RESIDUAL ORGANIC MATTER MANAGEMENT**D- 1.4.2.1 Performance of composting toilet processors**

Drying of fecal matter was established to be inadequate for sanitation, due to poor pathogen attenuation and risk of re-growth on moistening, particularly where stored material was poorly aerated (Austin 2001). Vault toilets are to be addressed as holding tank systems (with off-site discharge of collected material), and dried fecal matter is specified to be unsuitable for burial unless subjected to a composting or sanitizing step.

Literature review identified the widely reported risk that small scale (residential) composting toilet systems and larger scale (public use) systems may not perform as planned. Processors in many cases not reach target mesophilic or thermophilic temperatures, may suffer from poor aeration and poor moisture control, suffer from operation and maintenance issues, and that leachate in continuous process systems may re-contaminate matured material, resulting in higher than expected pathogen levels in residual organic matter (Caroline Schönning 2003; Enferadi 1986; Geoffrey B. Hill, Baldwin, and Vinnerås 2013; Geoffrey Becker Hill 2013).

To address this risk several strategies relating to the composting toilet and processor were used in this Manual:

- Educational material for APs, identifying risk factors for poor system performance was included.
- Standards for sanitizing steps were developed.
- Standards for aeration and moisture content were included.
- Urine diversion and urinal provision was encouraged.
- The primary purposes of the composting toilet were identified as relating to safe and hygienic collection and storage of waste, with a secondary objective of volume and mass reduction.
- Off-site discharge (removal to an approved facility) was established as the primary residual organic matter management option
- For on-site discharge a requirement for either a batch sanitizing step or long term batch curing was established.
- Documented monitoring of process by or with the review by an AP was required.
- Testing of residual organic matter prior to on-site discharge was required.

Further risk management was used at the on-site burial or on-site surface discharge step. The standards emphasize that residual organic matter is to be identified as a potential biohazard in all cases (Schonning et al. 2007; AS/NZS 2008).

It was considered necessary to assess both stability and maturity for composting toilet residual organic matter in order to establish level of risk for burial or on-site surface discharge (CCQC 2001; Geoffrey Becker Hill 2013). Maturity of compost is also relevant to the risk of pathogen regrowth (Elving 2009).

For stability and maturity, guidance documents by the Canadian Council of Ministers of the Environment (CCME) and by the California Compost Quality Council (CCQC) were used as the source of standards (CCME 2005; CCQC 2001). Given the need for a simple test appropriate for implementation on site by practitioners a commercial test method (Solvita) is offered in the standards (CCME 2005; Venelampi et al. 2006; Changa et al. 2003; CCQC 2001; Cabañas-Vargas et al. 2005; Geoffrey Becker Hill 2013; Wichuk and McCartney 2010). The Solvita method was considered more suitable for application as a field test by practitioners, in addition, the test includes evaluation of ammonia, an important factor in potential pollution from ground discharge. Given the wide range of potential sampling, analytical and measurement methods, the option for professional involvement is also available.

D- 1.4.2.1.(a) Off-site discharge

Residuals quality for off-site discharge are not defined by this Manual. The process is similar to that for septic tank sludge, with no requirement for any particular level of stabilization. Standards are limited to risk management during pump out or removal of the residuals.

D- 1.4.2.1.(b) Ground discharge (burial)

Storage time for psychrophilic curing of aerobic compost was established to provide inactivation of key pathogens, with minimum aerobic storage time of 1.5 years in temperate climate conditions and increased time for cold climate conditions based on normal survival times (R. G. Feachem et al. 1983; Olson, n.d.; Austin 2001; Strauss 1996; WHO 2006; C. Schönning and Stenström 2004; Schonning et al. 2007).

Burial of residual organic matter from composting toilets is widely permitted by code or regulation in the USA, with little control beyond a standard for cover soil depth.

In a similar way to pathogen levels for Type 1 or 2 effluent in the BC SPM, testing of pathogen indicator levels prior to discharge is not mandated, risk management being based a multi barrier approach:

- Long curing time specified, to result in inactivation of pathogens in typical conditions
- Increased curing time at low temperatures
- Conservative pathogen levels in residual organic matter to represent maximum survival times
- Requirement for batch process only and conservative aerobic curing period
- Testing to confirm low levels of ammonia
- Conservative soil based treatment standards
- Burial only in summer months, to allow time for treatment by soil organisms prior to heavy rainfall and to improve virus attenuation in warm, drier, soil conditions
- The provision of cover soil and a no disturbance period reducing risk from helminthes and from inhalation hazards (Aspergillus)
- Management and monitoring by an Authorized Person, with record keeping standards
- Owner education

- Small scale system application only.

See C- 1.4.6 for information on risk related to metals in human excreta.

Loading rate to soils and soil vertical separation, horizontal separation were based on the same considerations as for Type 2 gravity dispersal systems in the BC SPM, see the SPM for rationale and further discussion. Calculation of HLR is based on the moist mass of the residual organic matter.

Choice of equivalency for application of the SPM soil based treatment standards was based on semi-quantitative assessment:

- Fecal coliform level equivalent to adopted value for Type 2 effluent used in development of SPM standards (representing maximum viral risk for stored fecal compost).
- HLR for Type 2 effluent at 65 L/day/m² at DDF (32.5 L/day/m² at average daily flow), representing highest SPM Type 2 HLR is similar to average daily rainfall (29 mm/day with runoff factor of 0.8) for Lake Cowichan for wet season wettest week, representative of upper limit of SPM rainfall for standard soil loading rates.
- Pathogens applied in residual organic matter are leached over a one week period, with loading rate adjusted by a factor of 7 at average day flow.

Pathogen indicator levels representing risk for ground discharge were estimated for composting process with no thermophilic step and a storage period at ambient temperatures, based on survival and consideration of risk levels for pathogen indicators and viral pathogens in stored fecal organic matter identified by literature review (C. Schönning and Stenström 2004; Tønner-Klank et al. 2007; WHO 2006; Schonning et al. 2007). Risk analysis identified that on-site surface discharge of untested residual organic matter could lead to unacceptable risk levels, particularly with systems with more than one residence contributing material, or with colder storage temperatures, and supports the standard requirement for burial.

Viral risk was identified as the controlling risk factor for consideration when developing standards for burial, as survival of the majority of bacterial pathogens in applied material will be low, and leaching transport of protozoa and helminth ova will be low in soils (and soil cover plus a long no-disturbance period is specified to control soil ingestion risk).

Pathogen levels were adjusted from levels in feces (median 8.5 Log₁₀ FCB/g dry wt) by a factor of -5 Log₁₀ to represent attenuation in storage and attachment to biosolids, resulting in a conceptual equivalent E. coli FCB indicator level of 3.5 Log₁₀ units per g. dry weight or 4.9 Log₁₀ per 100 g moist weight. SPM soil based treatment standards considered an FCB indicator level of for Type 2 effluent of 5 Log₁₀ per 100 mL. Helminth ova inactivation during specified processes was taken to meet minimum 6 Log₁₀ reduction (Nordin, Nyberg, and Vinneras 2009).

This basis is very conservative, given that:

- Discharge is in one "dose" of aggregated material separated by years, versus daily application of non-aggregated effluent during that period.
- Discharge is solid phase, requiring leaching of pathogens prior to transport (see below).
- For collected and aggregated feces from an extended period of use the proportion of fecal matter containing pathogens will be very low, representing excreta deposited during a period of infection being diluted by the majority of excreta from non-infected individuals.
- Dilution by bulking agents is not considered.
- The standards of this Manual mandate a long aerobic curing period.

- The standards of this Manual mandate summer burial only.

Loading to soil is conservative:

- Discharge of contaminated biosolids to soils at low loading rates and with an adequate vadose zone and suitable soils for soil based treatment has not been demonstrated to cause pathogen contamination of groundwater (NRC (US) 2002).
- A "dose" is made with a minimum period with no disturbance prior to re-use of the same discharge location.
- Viruses have been demonstrated to be strongly embedded or adsorbed to biosolids and not rapidly or readily leached, requiring multiple (>50) extractions to reach maximum 8% detachment (Chetochine et al. 2006; Pepper et al. 2008). Attachment is partially represented in consideration of pathogen level, but this consideration indicates that loading is likely to be spread over a minimum period in weeks, rather than a single week.
- Viral inactivation in warm, dry soil conditions with applied biosolids has been demonstrated to be rapid, and even in the case where viral particles have leached from applied biosolids by irrigation or rainfall the leached particles have been shown to be inactive (Straub, Pepper, and Gerba 1992; Straub, Pepper, and Gerba 1995).

Risk from helminth pathogens (which may survive as viable ova beyond the minimum specified curing period) is additionally managed by burial cover standards, and standards for non-disturbance of the burial area. Length of time for no disturbance for buried material was based on maximum and T_{90} reported survival time in soil for viable helminth ova, with consideration of survival in the specified standard processes and maturation (curing) periods required prior to discharge (Caroline Schönning 2003; R. Feachem, Mara, and Bradley 1983; Holmqvist and Stenström 2001; Tønner-Klank et al. 2007; Schönning et al. 2007).

Risk from handling stored (matured) residual organic matter during the burial process was evaluated by Schönning et al. in the Danish setting, with risk to the person applying the material by soil spreading (without precautions) at 50th percentile 2×10^{-6} for Rotavirus and 6×10^{-5} for Ascaris after 12 months' storage. 95th percentile risk for Rotavirus was estimated at 3×10^{-2} (Schönning et al. 2007). Based on the objective of less than 10^{-4} increase in risk, the standards of this Manual added the following risk management strategies:

- Burial by or under the supervision of an Authorized Person (trained in proper precautions).
- Precautions for operator, including protective clothing and mask.
- Increased storage time, to 18 months or alternative sanitizing step(s).

Mulch material from mulch basin system mulch basin systems or seasonal urine dispersal system mulch basin systems will have a pathogen load. Cover mulch from chamber systems will have lower pathogen levels, since it is collected from above the infiltrative surface but is still considered to be a risk. However, as the pathogen load will be lower than defined for minimum quality of composting toilet residual organic matter for on-site burial, and as the mulch basin already relies on "burial" of the mulch media in the basin then it was considered appropriate to specify on-site burial of mulch removed from mulch basins. Other mulch materials from greywater or combined wastewater treatment or dispersal systems may contain higher levels of accumulated contaminants, and are therefore not included in the on-site burial standards.

D- 1.4.2.1.(c) On-site surface discharge

On-site surface discharge guidance is restricted to small, residential use, sites. This restriction was based on a qualitative assessment of relative risk of disease from contact with treated residual organic matter (during and after discharge), versus risk from disease transmission within the household. This approach was similar to that for residential greywater applied to mulch basin systems, see Section D- 1.3.5.1 and Section D- 1.4.3.3.(b).

Process and quality guidelines for residual organic matter were based on performance equivalency to standards specified in Canadian, US, EU and Australian/New Zealand regulations and code for waste products which will be discharged or applied to land. Recommendations for additional curing time were specified to further reduce pathogen risk. Pathogen indicator objective levels and testing guidelines were based on NSF41 and AS/NZS 1546.2-2008 test protocols for composting toilet systems (AS/NZS 2008). Stability and maturity standards were based on the Guidelines for Composting Quality prepared by the Canadian Council of Ministers of Environment (CCME 2005).

On-site surface discharge loading rate guidelines were based on achieving pathogen removal in soils following similar rationale to that for on-site burial. SPM standard Type 3 HLR were used as the basis of comparison. Loading rates are lower than for burial of residual organic matter, but given the areal loading of material the minimum required site area is very small. Actual loading rates are more likely to be controlled by site and project specific nutrient balance calculations.

The vertical separation standard was based on comparison to SPM loading and vertical separation standards for Type 3 effluent, based on uniform distribution and demand dosing (representative of areal loading with evenly spread material and intermittent rainfall input). An all season vertical separation was recommended to address longer term leaching of nutrients from the material.

Contact risk and risk from helminth pathogens were considered in by qualitative comparison to Canadian and US regulatory requirements and AS/NZS code. Contact risk was additionally mitigated by recommended:

- Extended curing periods
- Testing to conservative performance standard
- Access and usage type restrictions after surface discharge
- Restriction to small, residential, use sites
- Incorporation of material specified as the preferred method
- Hygiene practice standards for handling of residual organic matter

There is a low risk of metals contamination in residential settings, with metal levels in composting toilet organic matter predicted to be two orders of magnitude below Canadian standards for applied wastes, based on adopted values from literature review and conservative mass reduction in composting (Vinnerås 2002b; Palmquist 2004; H. Jönsson et al. 2005; Udert and Lienert 2013). Likewise, levels of industrial organic chemicals are expected to be low. For this reason, testing for metals and industrial chemical levels in residential composting toilet residual organic matter is not necessary in order to predict compliance with guideline maximum concentrations.

In order to address health and environmental risk from discharge, professional involvement is specified by the standards and the guidelines recommend use of a surface discharge plan which involves professional planning and management of discharge.

D- 1.4.3 SOURCE SEPARATED WASTEWATER SYSTEMS

Standards were developed based on SPM standards and supporting rationale. To provide simplified standards, where practical sizing or loading rate standards of this Manual were based on the SPM standards with adjustment factors.

Other source separated wastewater streams were considered along with greywater, to reduce repetition and complexity of standards.

D- 1.4.3.1 Wastewater characteristics and design flows

Source separated waste streams show higher variability in flow and characteristics for each stream than for combined sewage. Water conservation practices has impacted the relative proportion of water contributed by separate waste streams.

For simplicity of application, and particularly for consistency with the BC SPM, this Manual uses a common peaking factor of 2 for all flows. This peaking factor is not intended to accurately predict peak flows for the system, but rather to provide a “daily design flow” for system selection and sizing. See the SPM Volume IV for discussion of this factor.

Urine per use volume estimate is based on an average 215 mL/use and 7 urination events per day (5 to 10 as typical range), relating to the selected average 1.5 L/c/day urine flow. For urine storage a peaking factor of 1.3 is based on literature values for urine excretion.

Blackwater typical characteristics were calculated based on adopted excreta and blackwater flow values in this Manual, with TSS values based on Goonetilleke et. al (Goonetilleke, Dawes, and Biddle 2002). Brownwater nitrogen level was inferred from relative contributions of feces and urine. For simplicity, blackwater and brownwater are treated in the same way by the standards in terms of septic tank sizing and loading rate selection.

Flow volumes and constituent characteristics were based on analysis of data from a wide literature review, and were adjusted (based on per capita values) to match SPM standard average sewage flow and sewage strength assumptions, key references included (Laak 1986; Finch, Lesikar, and Innis 2002; Oldenburg et al. 2008; Meinzinger and Oldenburg 2009; Henze and Comeau 2008; Udert and Lienert 2013; WHO 2006; Vinnerås 2002b; H. Jönsson et al. 2005; Telkamp and Braadbaart 2006; Pi et al. 2006; Travis et al. 2010; P. Ridderstolpe 2004; Birks and Hills 2007; Diaper, Toifl, and Storey 2008; Toifl et al. 2006; E. Friedler 2004; Jefferson et al. 2004; Al-Jayyousi 2003; Palmquist 2004; Crook and Rimer 2009; Donner et al. 2008; Lowe et al. 2009a; Sheikh 2010; Christova-Boal et al. 1995; Ottoson 2004).

Adopted representative fecal coliform bacteria levels for raw combined greywater were developed for use in comparative modeling of pathogen attenuation in the soil treatment unit (see Section D- 1.3.5.1) and were based on a combination of literature review and calculation of contribution from fecal load (R. G. Feachem et al. 1983; Siegrist, Witt, and Boyle 1976; O’Toole et al. 2012; S Fiona Barker 2012; Rose et al. 1991; Ottoson and Stenström 2003; H. Jönsson et al. 2005; Brandes 1978; PHCC 1992).

As a conservative measure, the adopted combined greywater value of mean 1.5×10^5 CFU/100 mL was used with all greywater types. Removal rate for pathogens in greywater septic tank systems were based on values for E. coli attenuation in residential septic tank systems, resulting in a more conservative removal rate of 0.45 log₁₀ (Lowe et al. 2009b).

Note that, as described in Section D- 1.3.5.1, these fecal coliform values are not intended to represent normal values for greywater, but rather to serve as suitable representative values for input to pathogen removal modeling and analysis.

D- 1.4.3.2 Treatment standards

Due to differences in the character of source separated wastewater streams from domestic sewage, treatment of urine, leachate and greywater requires different considerations.

D- 1.4.3.2.(a) Septic tanks

Greywater flow volumes are lower than for combined sewage. In addition, sludge and scum accumulation rates are considerably lower for greywater systems. For this Manual septic tank size standards and guidance is based on an annual average sludge and scum accumulation rate of 16 L/c/year adjusted for volume reduction over time and a target pump out interval of 5 to 10 years and adjusted to a 95% confidence level, resulting in 140 L/c total accumulation (Brandes 1978; T. R. Bounds 1997; T. Bounds 1990; Bahe et al. 2008; Laak 1986; J. H. T. Winneberger 1984; J. H. Winneberger 1974; Gutterer et al. 2009; Crites and Tchobanoglous 1998). As practical tank size selection is limited, and as it is necessary to provide access and an effluent filter, actual tank size for small dwellings may be larger than the minimum working volume.

Garburator impact on greywater septic tanks is more severe than for tanks receiving sewage, and standards for sizing tanks where a garburator is used consider the increase in organic and solids mass loading to the greywater system (Jeppsson et al. 2005; J. H. Winneberger 1974).

Standards for blackwater septic tanks considered the high solids load of this source separated stream (approx. 3 x that for domestic sewage), typical sludge accumulation rate for blackwater septic tanks (approx. 0.8 x the per capita rate for combined sewage tanks) (Goonetilleke and Dawes 2001; Goonetilleke, Dawes, and Biddle 2002; Brandes 1978). For water separated from blackwater, tank sizing is conservatively based on SPM standards for combined sewage, to provide increased retention time to address residual finely divided and mixed solids, and a minimum tank size is based on allowance for sludge accumulation.

Other aspects of septic tank design and selection are recommended to follow standard practice for tanks receiving domestic sewage, since although the flow to the tank will be lower, the tank will be smaller, resulting in a similar requirement for separation from sludge layer to the effluent filter intake (for example) (J. H. Winneberger 1974; Laak 1986; Goonetilleke, Dawes, and Biddle 2002). Shallower tanks with a long narrow shape are preferred (T. R. Bounds 1997; Laak 1986).

For small tanks, a second compartment is likely to degrade performance (Ducoste et al. 2008a; Ducoste et al. 2008b; Crites and Tchobanoglous 1998). A minimum length inlet to outlet of 1 m is recommended, based on trial calculation of desirable tank geometry and on typical US standards (Bahe et al. 2008).

For large flow systems the use of a tank sized as for a combined sewage system at 5 times the estimated ADF, or professional selection of the tank is recommended (Crites and Tchobanoglous 1998).

For some wastewater streams flow is very low. In these cases septic tank size is controlled by geometry, particularly by the need to accommodate installation of an effluent filter, and to reduce the risk of short circuiting between inlet and outlet of the tank (T. R. Bounds 1997). In these cases, this Manual recommends use of a tank sized to suit the requirements for a combined greywater (CGW) system tank and establishes a minimum tank size (to allow for adequate geometry).

Dark greywater tank sizing and configuration is based on grease interceptor performance as well as estimated sludge accumulation volume, and again establishes a minimum tank size. Since in the case of DGW or leachate influent strength is considerably higher than for CGW, this minimum tank size is also intended to improve treatment of this high strength waste. For DGW tanks where a professional is custom sizing the tank, the Manual recommends selection and design include consideration of grease interceptor design with a performance target of maximum 15 mg/L Oil and Grease in effluent (Ducoste et al. 2008a; Ducoste et al. 2008b).

For light and very light greywater streams, flow and solids levels are lower. While this might be seen to justify a smaller tank size, the Manual provides standards based on CGW for all systems. This is for simplicity, to address the greater variability of flow for separated streams and to address high surge flows for laundry and tub flows.

D- 1.4.3.2.(b) Septic tank greywater and source separated wastewater effluent

Estimates of typical values for quality of greywaters post septic tank and effluent filter was based on literature values and modeling of tank performance (Gutterer et al. 2009; Brandes 1978; Siegrist and Boyle 1981; T. R. Bounds 1997; Bahe et al. 2008; T. Bounds 1990; J. H. T. Winneberger 1984; Laak 1986; J. H. Winneberger 1974; Hocaoglu et al., n.d.; Selda Murat Hocaoglu 2013; Joy, King, and Howes, n.d.; Crites and Tchobanoglous 1998; Almoayied K Assayed 2010).

For blackwater estimates were based on consideration of tank performance and on literature values (Goonetilleke, Dawes, and Biddle 2002; T. R. Bounds 1997; Laak 1986; Brandes 1978).

Consideration was also given to the performance of grease interceptors, and septic tanks receiving high strength greywater, particularly for dark greywater septic tanks (Ducoste et al. 2008a; Almoayied K Assayed 2010).

Standards for blackwater septic tank effluent are based on performance of blackwater tanks (Goonetilleke and Dawes 2001; Goonetilleke, Dawes, and Biddle 2002; Brandes 1978).

D- 1.4.3.2.(c) Urine storage

Source separated urine may contain pathogens from the urine stream (in rare cases), and more importantly may contain fecal or blood contamination (Höglund 2001). Storage of undiluted urine is effective in reducing pathogen levels, or, with adequate time and temperature, sterilizing the stored urine (Höglund 2001; Lennartsson and Ridderstolpe 2001; C. Schönning and Stenström 2004; WHO 2006; Orumwense, Torvinen, and Heinonen-Tanski 2013; Vinnerås et al. 2008).

As the SSR requires sub surface discharge, risk management for urine discharge or fertigation with urine does not necessitate complete disinfection. However, reduced pathogen levels expected after extended storage allow for application of urine diluted with fresh water to be used for diversion mulch basin fertigation even when collected from non-residential or large flow systems (where light greywater diversion with direct discharge to mulch basins is not supported due to higher risk of infection after contact with mulch or soil). Stored urine is also appropriate for addition to light greywater diversion systems with mulch basin irrigation for small residential flows, since pathogen level will be considerably lower than in the source separated greywater.

Specified storage time for residential systems is considered to be conservative, allowing for a minimum 90% reduction in viral risk even at lower temperatures and very low risk from bacterial contaminants. Storage time for larger systems is more stringent, to represent higher risk and to meet WHO guidelines for restricted irrigation of food crops that are to be processed, even where temperatures fall below the specified minimum 10 C for significant periods.

For use after collection without storage, risk is addressed by allowing for sub irrigation to non-mulch basin systems only for larger flow or non-residential systems.

D- 1.4.3.3 Dispersal standards

In general, dispersal standards of this Manual follow those of the BC SPM. In certain cases, standards have been developed to address particular effluent types and to address diversion systems used only during the irrigation season.

For diversion systems it is expected that only a small part of the applied water will flow to the base of the vadose zone. The primary purpose of the system is to provide irrigation water and nutrients to growing plants, and an alternative discharge method is available for times when soil moisture content is higher or when plants will not be taking up nutrients. For this reason, development of maximum HLR standards for these systems is based on the maintenance of unsaturated (moist field capacity) flow and acceptable organic mass loading at the infiltrative surface, with less stringent consideration of pathogen attenuation or nitrogen loading in comparison to non-diversion systems.

D- 1.4.3.3.(a) Soil hydraulic loading rates

As wastewater streams differ in strength in comparison to Type 1 effluent, the HLR standards of the SPM for Type 1 effluent are modified to address organic mass loading to the infiltrative surface.

In the majority of cases loading rates are the same as or slightly lower than for Type 1 effluent. As greywater typically has lower pathogen load than Type 1 effluent, or in the worst case the same, pathogen attenuation considerations are conservatively addressed in these cases. For light greywater, or light greywater combined with urine, pathogen load will typically be lower than Type 1 effluent and a slight increase in HLR is not expected to impact pathogen attenuation, provided other standards of the SPM are followed.

The calculation of adjustment factors for differing wastewater streams is based on the same mass loading and pathogen attenuation considerations as for the SPM HLR (see SPM Volume IV). For discharge of composting toilet leachate or diluted urine a lower loading rate is selected to address nitrogen loading, however, as the volume of these streams is very small, the discharge area will still be very small.

For seasonal diversion systems the goal, as noted above, is to avoid organic overloading of the infiltrative surface and to ensure unsaturated flow conditions are maintained below the mulch system. Soil organic loading considerations and unsaturated hydraulic conductivity considerations follow those used in development of the SPM HLR standards (as described in SPM volume IV). For ease of application of standards, a multiplier factor is specified, in relation to SPM soil HLR for Type 1 effluent.

D- 1.4.3.3.(b) Mulch basins

In a mulch basin system light greywater is seasonally applied at relatively high loading rate to ground or finely chipped bark, bio-char or charcoal (Ludwig 2000; P. Ridderstolpe 2004). The bark provides an environment for removal of organics, suspended solids, oils and greases and attenuation of nutrients and pathogens. At the base of the bark layer effluent flows to native soil or sand media, which over time becomes enriched with the organic material from the basin. Basins are planted with tree or shrub crops that are intended to benefit from the wastewater application.

This Manual specifies dispersal to mulch basins with mulch as the infiltrative surface for use with small flow residential seasonal diversion systems only, and when greywater is discharged, only for light greywater or light greywater mixed with urine. This approach is based on qualitative, multi barrier, consideration of risk, particularly:

- Lower risk attached to light greywater from residential, small flow systems where risk of disease transmission is predicted to be higher from other pathways in a household with an infected individual.
- Lower risk attached to light versus dark greywater, particularly for food pathogens (e.g. Salmonella, E. coli)
- Lower risk for pathogen transmission and infiltrative surface plugging for seasonal systems
- Lower risk for seasonal irrigation systems due to applied water largely being evaporated or transpired, resulting in reduced proportion of pathogens and nutrients reaching the limiting layer and in improved soil based treatment.

- Low risk of water table mounding below seasonal irrigation systems.

For larger flow or non-residential systems dispersal to a mulch infiltrative surface is limited to stored urine diluted with fresh water (which is expected to have very low or no pathogen content as discussed in Section D-1.4.3.2.(c)). This standard also allows an option for remote site composting toilet systems with urine diversion, where seasonal discharge is needed to address site constraints.

Two loading rates must be considered, that for the bark or other organic material, and that for the basal area—similar to the situation for a sand mound.

In all cases loading rate to the bark or other media is based on consideration of allowable organic loading rate, which is controlling for filter performance, with a conservative loading rate and media depth standard developed based on review of literature in the field of organic filter performance (Lightsey 1977; Mitchell 1975; Berger 2012; Cropsey and Weswig 1973; S. S. Dalahmeh et al. 2011; S. Dalahmeh 2013; S. S. Dalahmeh et al. 2014; S. S. Dalahmeh et al. 2012; Lalander et al. 2013; Sidibe 2014; Ruane et al. 2011; Schmidt, Janni, and Christopherson 2008).

For mulch basin media to function as planned, and to reduce the need for intensive maintenance, it is important that the material maintains a loose structure that is highly air permeable. The role of macro fauna is important in maintenance of the basin, and the mulch system may be seen as similar to vermicomposting or a vermicompost filter (Peter Ridderstolpe 2007).

The selected “favorable media” HLR is based on conservative loading rates for bark (with organic loading rate of maximum 55 g BOD/day/m²), considered to result in reasonable (5 to 10 year) lifespan for the bark media which is in direct contact with greywater and performance to meet minimum 90% BOD removal, 1 log₁₀ viral removal in 30 cm depth of media. The selected “acceptable” media HLR is based on a maximum organic loading rate of 15 g BOD/day/m² to media considered to provide less effective treatment, or to have lower permeability.

Favorable media is identified as finer (1 to <20 mm effective diameter), relatively uniform, ground bark, peat, coconut coir, bio-char or charcoal. Minimum hydraulic conductivity values are based on relative soil loading rates and on literature values for media (L. Christianson et al. 2010).

The basal loading rate, dispersal system selection and selection of basal VS is to follow SPM standards (as noted elsewhere). Basal HLR may be as for Type 2 effluent, based on BOD levels and allowable mass loading to soils, but in some cases lower HLR may be selected to allow simpler dispersal methods or shallower VS.

Where compost, mulch or coarser material (25 to 90 cm effective diameter) is used the media performs more as a trickling filter and a greater depth of media (60 to 90 cm) is necessary to provide target BOD removal, or Type 2 basal HLR should not be used (S. S. Dalahmeh et al. 2011). For simplicity of standards, in the case of “acceptable” media normal light greywater or diluted urine HLR is specified for the basal soils.

D- 1.4.3.3.(c) Contour loading

For all season systems, contour length selection for source separated wastewater systems follows the SPM. In some cases, systems may be very short (example discharge of composting toilet leachate), but system contour length is still calculated following the same rationale as for the SPM.

For mulch basin systems contour loading is not a critical consideration, since, as noted above, these systems are to be operated to avoid deep percolation of water below the system.

D- 1.5 Bibliography

- Al-Jayyousi, O. R. 2003. "Greywater Reuse: Towards Sustainable Water Management." *Desalination* 156 (1–3): 181–92.
- Almoayied K Assayed, Sahar S. Dalahmeh. 2010. "Onsite Greywater Treatment Using Septic Tank Followed by Intermittent Sand Filter-A Case Study of Abu Al Farth Village in Jordan" 1.
- AS/NZS. 2008. "AS/NZS 1546.2:2008 On-Site Domestic Wastewater Treatment Units - Waterless Composting Toilets."
- Atmar, Robert L., Antone R. Opekun, Mark A. Gilger, Mary K. Estes, Sue E. Crawford, Frederick H. Neill, and David Y. Graham. 2008. "Norwalk Virus Shedding after Experimental Human Infection." *Emerging Infectious Diseases* 14 (10): 1553–57. doi:10.3201/eid1410.080117.
- Austin, Aussie. 2001. "Health Aspects of Ecological Sanitation." In *Abstract Volume, First International Conference on Ecological Sanitation*, 5:104–11.
- Bahe, A., B. Comstock, T. Konsler, S. K. Liehr, S. C. Long, K. Ratanaphruks, C. A. Rock, and P. E. Kevin Sherman. 2008. *FACTORS AFFECTING THE PERFORMANCE OF PRIMARY TREATMENT IN DECENTRALIZED WASTEWATER SYSTEMS*. WERF, Water Environment Research Foundation.
- Berger, Christina. 2012. "Biochar and Activated Carbon Filters for Greywater Treatment."
- Birks, R., and S. Hills. 2007. "Characterisation of Indicator Organisms and Pathogens in Domestic Greywater for Recycling." *Environmental Monitoring and Assessment* 129 (1): 61–69.
- Bounds, T. 1990. "Glide Audit 1986-1987 Summary of Sludge and Scum Accumulation Rates." In .
- Bounds, T. R. 1997. "Design and Performance of Septic Tanks." In *Site Characterization and Design of On-Site Septic Systems*, 217. ASTM.
- Brandes, M. 1978. "Characteristics of Effluents from Gray and Black Water Septic Tanks." *Journal (Water Pollution Control Federation)*, 2547–59.
- Cabañas-Vargas, D. D., Miguel Ángel Sánchez-Monedero, S. T. Urpilainen, A. Kamilaki, and E. I. Stentiford. 2005. "Assessing the Stability and Maturity of Compost at Large-Scale Plants."
- CCME. 2005. "Canadian Council of Ministers of the Environment (CCME), Guidelines for Compost Quality." Canadian Council of Ministers of the Environment.
- . 2010. "A Review of the Current Canadian Legislative Framework for Wastewater Biosolids." Canadian Council of Ministers of the Environment.
- CCQC. 2001. "Compost Maturity Index." California Compost Quality Council.
- CDC. 2002. "CDC Guidelines for Hand Hygiene in Healthcare Settings." CDC.
- Changa, C. M., P. Wang, M. E. Watson, H. A. J. Hoitink, and F. C. Michel Jr. 2003. "Assessment of the Reliability of a Commercial Maturity Test Kit for Composted Manures." *Compost Science & Utilization* 11 (2): 125–143.
- Chetochine, Alexandra S., Mark L. Brusseau, Charles P. Gerba, and Ian L. Pepper. 2006. "Leaching of Phage from Class B Biosolids and Potential Transport through Soil." *Applied and Environmental Microbiology* 72 (1): 665–71. doi:10.1128/AEM.72.1.665-671.2006.
- Christova-Boal, D., P. Lechte, R. Shipton, and Victoria University of Technology. Dept. of Civil and Research Engineering. 1995. *Installation and Evaluation of Domestic Greywater Reuse Systems*. Dept. of Civil and Building Engineering, Victoria University of Technology.
- Crites, R., and G. Tchobanoglous. 1998. *Small and Decentralized Wastewater Management Systems*. WCB/McGraw-Hill Boston.
- Crockett, Jonathan. 2003. *Feasibility Study for a Dry Composting Toilet and Urine Separation Demonstration Project*. GHD.
- Crook, James, and A.E. Rimer. 2009. "Technical Memorandum on Greywater." Black and Vetch.
- Cropsey, Myron George, and Paul Henry Weswig. 1973. "Douglas-Fir Bark as a Trickling Filter Medium for Animal Waste Disposal Systems." Corvallis: Agricultural Experiment Station, Oregon State University.
- Dalahmeh, Sahar. 2013. "Bark and Charcoal Filters for Greywater Treatment."

- Dalahmeh, Sahar S., Lars D. Hylander, Bjorn Vinneras, Mikael Pell, Ingrid Oborn, and Hakan Jonsson. 2011. "Potential of Organic Filter Materials for Treating Greywater to Achieve Irrigation Quality: A Review." *Water Science & Technology* 63 (9): 1832–40.
- Dalahmeh, Sahar S., Mikael Pell, Lars D. Hylander, Cecilia Lalander, Björn Vinnerås, and Håkan Jönsson. 2014. "Effects of Changing Hydraulic and Organic Loading Rates on Pollutant Reduction in Bark, Charcoal and Sand Filters Treating Greywater." *Journal of Environmental Management* 132 (January): 338–45. doi:10.1016/j.jenvman.2013.11.005.
- Dalahmeh, Sahar S., Mikael Pell, Björn Vinnerås, Lars D. Hylander, Ingrid Öborn, and Håkan Jönsson. 2012. "Efficiency of Bark, Activated Charcoal, Foam and Sand Filters in Reducing Pollutants from Greywater." *Water, Air, & Soil Pollution* 223 (7): 3657–71.
- Diaper, C., M. Toifl, and M. Storey. 2008. "CSIRO Greywater Technology Testing Protocol." *CSIRO: Water for a Healthy Country, National Research Flagship Report Series*.
- Donner, E., E. Eriksson, L. Scholes, and M. Revitt. 2008. *Priority Pollutant Behaviour in Treatment and Reuse Systems for Household Wastewater*. ScorePP.
- Ducoste, J. J., K. M. Keener, J. W. Groninger, and L. M. Holt. 2008a. "ASSESSMENT OF GREASE INTERCEPTOR PERFORMANCE." WERF.
- . 2008b. "FOG Interceptor Design and Operation (FOGIDO) Guidance Manual." WERF.
- E35 Committee. 2010. "Test Method for Determining the Bacteria-Eliminating Effectiveness of Hand Sanitizer Formulations Using Hands of Adults." ASTM International. <http://www.astm.org/Standards/E2755.htm>.
- Elving, Josefine. 2009. "Pathogen Inactivation and Regrowth in Organic Waste during Biological Treatment." Swedish University of Agricultural Sciences. <http://pub.epsilon.slu.se/id/file/3222>.
- Emmoth, Eva. 2010. "Virus Inactivation-Evaluation of Processes Used in Biowaste Management." Swedish University of Agricultural Sciences.
- Enferadi, K. M. 1986. *Field Investigation of Biological Toilet Systems and Grey Water Treatment*. US Environmental Protection Agency, Water Engineering Research Laboratory.
- Feachem, Richard G, David J Bradley, Hemda Garelick, and D. Duncan Mara. 1983. "Sanitation and Disease: Health Aspects of Excreta and Wastewater Management." 1. <http://go.worldbank.org/ZS7F3M9XG1>.
- Feachem, Richard, D. Duncan Mara, and David J. Bradley. 1983. *Sanitation and Disease*. John Wiley & Sons.
- Finch, C, B. A. Lesikar, and E. Innis. 2002. "Graywater Literature Search." Texas Onsite Wastewater Treatment Research Council.
- Friedler, E. 2004. "Quality of Individual Domestic Greywater Streams and Its Implication for on-Site Treatment and Reuse Possibilities." *Environmental Technology* 25 (9): 997–1008.
- Friedler, Eran, David Butler, and Y. Alfiya. 2013. "Wastewater Composition." In *Source Separation and Decentralization for Wastewater Management*. Edited by TA Larsen, K. Udert, and J. Lienert., 241–57. IWA Publishing, London, UK.
- Goonetilleke, Ashantha, and Les A. Dawes. 2001. "Audit of Septic Tank Performance."
- Goonetilleke, Ashantha, Les A. Dawes, and Dean Biddle. 2002. "Performance Evaluation of Septic Tanks in the Gold Coast Region."
- Gotass, H. B. 1956. "Composting." *WHO, Geneva, Switzerland*, no. Monograph No. 31.
- Government of Canada, Health Canada. 2010. "Canadian Guidelines for Domestic Reclaimed Water for Use in Toilet and Urinal Flushing [Health Canada, 2010]." Guide. July 16. http://www.hc-sc.gc.ca/ewh-semt/pubs/water-eau/reclaimed_water-eaux_recyclees/index-eng.php.
- Gutterer, Bernd, Ludwig Sasse, Thilo Panzerbieter, and Thorsten Reckerzügel. 2009. *Decentralised Wastewater Treatment Systems (DEWATS) and Sanitation in Developing Countries*. WEDC, Loughborough.
- Health Canada. 2012. "Guidelines for Canadian Recreational Water Quality." Health Canada.
- . n.d. "Antiseptic Skin Cleansers (Personal Domestic Use) - Under Consultation." Health Canada.
- Henze, Mogens, and Yves Comeau. 2008. "Wastewater Characterization." In *Biological Wastewater Treatment: Principles, Modelling and Design.*, 33–52. IWA Publishing, London.

- Hill, Geoffrey B., Susan A. Baldwin, and Björn Vinnerås. 2013. "Composting Toilets a Misnomer: Excessive Ammonia from Urine Inhibits Microbial Activity yet Is Insufficient in Sanitizing the End-Product." *Journal of Environmental Management* 119: 29–35.
- Hill, Geoffrey Becker. 2013. "An Evaluation of Waterless Human Waste Management Systems at North American Public Remote Sites."
- Hocaoglu, Selda Murat, Guçlu Insel, Emine Ubay Cokgor, Ahmet Baban, and Derin Orhon. n.d. "COD Fractionation and Biodegradation Kinetics of Segregated Domestic Wastewater: Black and Grey Water Fractions." *System* 29: 30.
- Hogg, Dominic, Josef Barth, Enzo Favoino, Massimo Centemero, Valentina Caimi, Florian Amlinger, Ward Devliegher, Will Brinton, and Susan Antler. 2002. "Comparison of Compost Standards within the EU, North America and Australasia." *Banbury: The Waste and Resources Action Programme (WRAP)*, 5–44.
- Höglund, Caroline. 2001. "Evaluation of Microbial Health Risks Associated with the Reuse of Source-Separated Humna Urine."
- Holmqvist, Annika, and Thor Axel Stenström. 2001. "'Survival of Ascaris Suum Ova, Indicator Bacteria and Salmonella Typhimurium Phage 28B in Mesophilic Composting of Household Waste.'" In *Abstract Volume, First International Conference on Ecological Sanitation*, 5:99–103.
- Jefferson, B., A. Palmer, P. Jeffrey, R. Stuetz, and S. Judd. 2004. "Grey Water Characterisation and Its Impact on the Selection and Operation of Technologies for Urban Reuse." *Water Science & Technology* 50 (2): 157–64.
- Jeppsson, Ulf, A. Baky, D. Hellström, H. Jönsson, and E. Kärrman. 2005. "URWARE Wastewater Treatment Plant Models." *Urban Water Rapport*.
- Jönsson, H., A. Baky, U. Jeppsson, D. Hellström, and E. Kärrman. 2005. "Composition of Urine, Faeces, Greywater and Biowaste for Utilization in the URWARE Model." 2005:6. The Mistra Programme: Urban Water. Gothenburg, Sweden: Chalmers University of Technology.
- Jönsson, Håkan, Anna Richert Stintzing, Björn Vinnerås, and Eva Salomon. 2004a. *Guidelines on the Use of Urine and Faeces in Crop Production*. EcoSanRes Programme.
- . 2004b. *Guidelines on the Use of Urine and Faeces in Crop Production*. EcoSanRes Programme.
- Joy, D. M., T. R. King, and A. Howes. n.d. "Temperature Profiles in a Granular Compact Filter and System Performance Under Cold-Weather Conditions."
- Kemmeren, Jeanet M., M. J. J. Mangen, YTHP Van Duynhoven, and A. H. Havelaar. 2006. "Priority Setting of Foodborne Pathogens: Disease Burden and Costs of Selected Enteric Pathogens."
- Laak, R. 1986. *Wastewater Engineering Design for Unsewered Areas*. Ann Arbor Science Publishers Ann Arbor, Mich.
- L. Christianson, A. Castelló, R. Christianson, M. Helmers, and A. Bhandari. 2010. "Technical Note: Hydraulic Property Determination of Denitrifying Bioreactor Fill Media" 26 (5): 849–54.
- Lalander, Cecilia, Sahar Dalahmeh, Håkan Jönsson, and Björn Vinnerås. 2013. "Hygienic Quality of Artificial Greywater Subjected to Aerobic Treatment: A Comparison of Three Filter Media at Increasing Organic Loading Rates." *Environmental Technology* 34 (18): 2657–62.
- Lennartsson, Maria, and Peter Ridderstolpe. 2001. "Guidelines for Using Urine and Blackwater Diversion Systems in Single-Family Homes." *Coalition Clean Baltic*.
- Lightsey, George R. 1977. "Detoxification by Bark Filtration of Shock Loads to Secondary Treatment Systems."
- Lowe, K. S, M. B Tucholke, J. Tomaras, K. E. Conn, C. Hoppe, J. Drewes, J. E McCray, and J. Munakata-Marr. 2009a. *Influent Constituent Characteristics of the Modern Waste Stream from Single Sources*. IWA Publishing.
- . 2009b. *Influent Constituent Characteristics of the Modern Waste Stream from Single Sources*. Iwa.
- Ludwig, A. 2000. *Create an Oasis with Greywater: Your Complete Guide to Choosing, Building, and Using Greywater Systems*. Oasis Design.

- Maiwals, M. 2009. "Systematic Review of the Efficacy of Alcohol Preparations and Other Agents for Hand Hygiene in the Healthcare Setting." Royal Darwin Hospital.
- Mara, Duncan, Andrew J. Hamilton, Andrew Sleigh, Natalie Karavarsamis, and Razak Seidu. 2010. "Tools for Risk Analysis: Updating the 2006 WHO Guidelines." *Astewater Irrigation*, 89.
- Mara, Duncan, Andrew Hamilton, Andrew Sleigh, and Natalie Karavarsamis. 2010. "Discussion Paper: Options for Updating the 2006 WHO Guidelines." *WHO, FAO, IDRC, IWMI*.
- Meinzinger, F., and M. Oldenburg. 2009. "Characteristics of Source-Separated Household Wastewater Flows: A Statistical Assessment." *Water Science and Technology: A Journal of the International Association on Water Pollution Research* 59 (9): 1785–91. doi:10.2166/wst.2009.185.
- Mitchell, John William. 1975. "Pine Bark as a Trickling Filter Media to Purify Waste Water Streams from a Kraft Pulp and Paper Mill."
- Münch, Elisabeth. n.d. "Characteristics of Urine, Faeces and Greywater." presented at the UNESCO-IHE.
- NHMRC. n.d. "AUSTRALIAN GUIDELINES FOR THE Prevention and Control of Infection in Healthcare." Commonwealth of Australia.
- Niwagaba, Charles, and Makerere University. 2009. "Treatment Technologies for Human Faeces and Urine." Uppsala: Department of Energy and Technology, Swedish University of Agricultural Sciences.
- Nordin, Annika. 2010. "Ammonia Sanitisation of Human Excreta." Uppsala: Swedish University of Agricultural Sciences.
- Nordin, Annika, Karin Nyberg, and Björn Vinneras. 2009. "Inactivation of Ascaris Eggs in Source-Separated Urine and Feces by Ammonia at Ambient Temperatures." *Applied and Environmental Microbiology* 75 (3): 662–667.
- NRC (US). 2002. *Biosolids Applied to Land: Advancing Standards and Practices*. Natl Academies Press.
- Oldenburg, Martin, Franziska Meinzinger, Peter Nisipeanu, and Christian Schneider. 2008. "Begrifflichkeiten Und Kennzahlen Zur Zusammensetzung von Teilstromen Neuartiger Sanitarsysteme." *KA Abwasser Abfall* 55 (10): 1113.
- Olson, M.E. n.d. "Human and Animal Pathogens in Manure." University of Calgary.
- Orumwense, Pedro Osagie, Eila Torvinen, and Helvi Heinonen-Tanski. 2013. "The Survival of Mycobacteria in Pure Human Urine." *Water Science and Technology: A Journal of the International Association on Water Pollution Research* 67 (8): 1773.
- O'Toole, Joanne, Martha Sinclair, Manori Malawaraarachchi, Andrew Hamilton, S. Fiona Barker, and Karin Leder. 2012. "Microbial Quality Assessment of Household Greywater." *Water Research* 46 (13): 4301–13. doi:10.1016/j.watres.2012.05.001.
- Ottoson, J. 2004. *Comparative Analysis of Pathogen Occurrence in Wastewater: Management Strategies for Barrier Function and Microbial Control*. Department of Land and Water Resources Engineering, Royal Inst. of Technology (KTH).
- Ottoson, J., and T.A. Stenström. 2003. "Faecal Contamination of Greywater and Associated Microbial Risks." *Water Research* 37 (3): 645–655.
- Palmquist, H. 2004. "Hazardous Substances in Wastewater Management." *Luleå University of*.
- Pepper, Ian L., Huruy Zerzghi, John P. Brooks, and Charles P. Gerba. 2008. "Sustainability of Land Application of Class B Biosolids." *Journal of Environmental Quality* 37 (5_Supplement): S-58-S-67.
- Petterson, S. A., and N. J. Ashbolt. 2005. "WHO Guidelines for the Safe Use of Wastewater and Excreta in Agriculture: Microbial Risk Assessment Section." In *WHO Guidelines for the Safe Use of Wastewater and Excreta in Agriculture Microbial Risk Assessment Section*. University of New South Wales.
- PHCC. 1992. "Assessment of On-Site Graywater and Combined Wastewater Treatment and Recycling Systems." PHCC and USEPA.
- PI, L.R., Y. Qian, M. Criswell, M. Stromberger, and S. Klein. 2006. "Long-Term Effects of Landscape Irrigation Using Household Graywater—Literature Review and Synthesis."

- Pittet, Didier, Benedetta Allegranzi, John Boyce, and World Health Organization World Alliance for Patient Safety First Global Patient Safety Challenge Core Group of Experts. 2009. "The World Health Organization Guidelines on Hand Hygiene in Health Care and Their Consensus Recommendations." *World Health* 30 (7): 611–22.
- Porto, David Del, and Carol Steinfeld. 2000. *The Composting Toilet System Book: A Practical Guide to Choosing, Planning and Maintaining Composting Toilet Systems, a Water-Saving, Pollution-Preventing Alternative*. 1.2. Center for Ecological Pollution Prevention.
- Ridderstolpe, P. 2004. *Introduction to Greywater Management*. EcoSanRes Programme, Report 2004-4. Stockholm Environment Institute.
- Ridderstolpe, Peter. 2007. "Mulch Filter and Resorption Trench for Onsite Greywater Management." *Report for a Demo Facility Built in Kimberley, South Africa. EcoSanRes Programme, Stockholm Environment Institute, Stockholm, Sweden*.
- Rose, Joan B., Gwo-Shing Sun, Charles P. Gerba, and Norval A. Sinclair. 1991. "Microbial Quality and Persistence of Enteric Pathogens in Graywater from Various Household Sources." *Water Research* 25 (1): 37–42.
- Ruane, Eimear M., Paul NC Murphy, Mark G. Healy, Pdraig French, and Michael Rodgers. 2011. "On-Farm Treatment of Dairy Soiled Water Using Aerobic Woodchip Filters." *Water Research* 45 (20): 6668–76.
- Rutjes, S. A., W. J. Lodder, A. Docters Van Leeuwen, and A. M. de Roda Husman. 2009. "Detection of Infectious Rotavirus in Naturally Contaminated Source Waters for Drinking Water Production." *Journal of Applied Microbiology* 107 (1): 97–105.
- S Fiona Barker, Joanne O''Toole. 2012. "A Probabilistic Model of Norovirus Disease Burden Associated with Greywater Irrigation of Home-Produced Lettuce in Melbourne, Australia." *Water Research*. doi:10.1016/j.watres.2012.12.012.
- Sahlström, Leena. 2006. *Recycled Biowaste as a Source of Infection*. Vol. 2006.
- Scheierling, Susanne M., Carl Bartone, Duncan D. Mara, and Pay Drechsel. 2010. "Improving Wastewater Use in Agriculture: An Emerging Priority."
- Schmidt, D.R., K.A. Janni, and S.H. Christopherson. 2008. "Milk House Wastewater Design Guide." University of Minnesota.
- Schönning, Caroline. 2003. "Recommendations for the Reuse of Urine and Faeces in Order to Minimise the Risk for Disease Transmission." In *ECOSAN—Closing the Loop* ", *Proceedings Zum 2nd Internat. Symposium on Ecological Sanitation, Lübeck*.
- Schonning, Caroline, Therese Westrell, T. Stenstrom, Karsten Arnbjerg-Nielsen, A. Hasling, Linda Hoibye, and Anders Carlsen. 2007. "Microbial Risk Assessment of Local Handling and Use of Human Faeces." *Journal of Water and Health* 5 (1): 117–28.
- Schönning, C., and T. A Stenström. 2004. *Guidelines on the Safe Use of Urine and Faeces in Ecological Sanitation Systems*. EcoSanRes Programme, Report 2004-1. Stockholm Environment Institute.
- Selda Murat Hocaoglu, Derin Orhon. 2013. "Particle Size Distribution Analysis of Chemical Oxygen Demand Fractions with Different Biodegradation Characteristics in Black Water and Gray Water." *CLEAN - Soil Air Water* 41 (11): 1044. doi:10.1002/clen.201100467.
- Sheikh, Bahman. 2010. "White Paper on Graywater." AWWA, WEF, WRA.
- Sidibe, Modibo. 2014. "Comparative Study of Bark, Bio-Char, Activated Charcoal Filters for Upgrading Grey-Water."
- Siegrist, Robert L., and William C. Boyle. 1981. "Onsite Reclamation of Residential Greywater." In *Proceedings of the Third National Symposium of Individual and Small Community Sewage Treatment*, 176–86. ASAE.
- Siegrist, Robert L., Michael David Witt, and William Charles Boyle. 1976. *The Characteristics of Rural Household Wastewater*. Small Scale Waste Management Project, University of Wisconsin--Madison and University of Wisconsin--Extension.

- Straub, Timothy M., Ian L. Pepper, and Charles P. Gerba. 1992. "Persistence of Viruses in Desert Soils Amended with Anaerobically Digested Sewage Sludge." *Applied and Environmental Microbiology* 58 (2): 636–41.
- . 1995. "Comparison of PCR and Cell Culture for Detection of Enteroviruses in Sludge-Amended Field Soils and Determination of Their Transport." *Applied and Environmental Microbiology* 61 (5): 2066–68.
- Strauss, Martin. 1996. "Health (Pathogen) Considerations Regarding the Use of Human Waste in Aquaculture." In *Environmental Research Forum*, 5:83–98.
- Suchomel, Miranda, Michael Kundi, Didier Pittet, Martina Weinlich, and Manfred L. Rotter. 2012. "Testing of the World Health Organization Recommended Formulations in Their Application as Hygienic Hand Rubs and Proposals for Increased Efficacy." *American Journal of Infection Control* 40 (4): 328–31.
- Telkamp, Paul, and Okke Braadbaart. 2006. "Separate Collection and Treatment of Domestic Wastewater in Norway." *Wageningen University, Wageningen*.
- Teunis, Peter F.M., Christine L. Moe, Pengbo Liu, Sara E. Miller, Lisa Lindesmith, Ralph S. Baric, Jacques Le Pendu, and Rebecca L. Calderon. 2008. "Norwalk Virus: How Infectious Is It?" *Journal of Medical Virology* 80 (8): 1468–76. doi:10.1002/jmv.21237.
- Toifl, M., G. Tjandraatmadja, C. Diaper, M. Storey, and R. O'Halloran. 2006. "Developing a Synthetic Greywater for Testing Greywater Technologies." *1ST AUSTRALIAN YOUNG WATER PROFESSIONALS, Sydney. 1st Australian Young Water Professionals. Sydney*.
- Tønner-Klank, L., Jacob Møller, Anita Forslund, and Anders Dalsgaard. 2007. "Microbiological Assessments of Compost Toilets: In Situ Measurements and Laboratory Studies on the Survival of Fecal Microbial Indicators Using Sentinel Chambers." *Waste Management* 27 (9): 1144–54.
- Travis, Micheal J., Alit Wiel-Shafran, Noam Weisbrod, Eilon Adar, and Amit Gross. 2010. "Greywater Reuse for Irrigation: Effect on Soil Properties." *Science of the Total Environment* 408 (12): 2501–8.
- Udert, Kai M., and Judit Lienert. 2013. *Source Separation and Decentralization for Wastewater Management*. IWA Publishing.
- US FDA. 1991. "Topical Antimicrobial Drug Products for Over-the-Counter Human Use; Tentative Final Monograph for First Aid Antiseptic Drug Products 21 CFR Parts 333 and 369." US FDA.
- . 2013. "Safety and Effectiveness of Consumer Antiseptics; Topical Antimicrobial Drug Products for Over-the-Counter Human Use; Proposed Amendment of the Tentative Final Monograph; Reopening of Administrative Record." US FDA.
- USEPA. 1999. "Water Efficiency Technology Fact Sheet Incinerating Toilets." USEPA.
- Venelampi, Olli, Minna Vikman, Anu Kapanen, and Merja Itävaara. 2006. "METHODS AND PROCEDURES TO ASSESS COMPOST MATURITY AND STABILITY." *VTT Tiedotteita – Research Notes* 2351. http://solvita.com/wp-content/uploads/2013/04/VTT_finland_comparison.pdf.
- Vinnerås, Björn. 2002a. *Possibilities for Sustainable Nutrient Recycling by Faecal Separation Combined with Urine*. Vol. 353.
- . 2002b. *Possibilities for Sustainable Nutrient Recycling by Faecal Separation Combined with Urine*. Vol. 353.
- Vinnerås, Björn, Annika Nordin, Charles Niwagaba, and Karin Nyberg. 2008. "Inactivation of Bacteria and Viruses in Human Urine Depending on Temperature and Dilution Rate." *Water Research* 42 (15): 4067–74.
- Ware, Sylvia A. 1980. *A Survey of Pathogen Survival during Municipal Solid Waste and Manure Treatment Processes*. Municipal Environmental Research Laboratory, Office of Research and Development, US Environmental Protection Agency.
- WHO. 2006. *WHO Guidelines for the Safe Use of Wastewater, Excreta and Greywater*. World Health Organization. http://www.who.int/water_sanitation_health/wastewater/gsuww/en/index.html.
- Wichuk, Kristine M., and Daryl McCartney. 2010. "Compost Stability and Maturity Evaluation — a Literature reviewA Paper Submitted to the Journal of Environmental Engineering and Science." *Canadian Journal of Civil Engineering* 37 (11): 1505–23. doi:10.1139/L10-101.

Winneberger, J. H. T. 1984. *Septic-Tank Systems: A Consultant's Toolkit*. Butterworth.
Winneberger, John HT. 1974. *Manual of Grey Water Treatment Practice*. Ann Arbor Science.

D- 2 DESIGN MANUALS AND ONLINE RESOURCES

The following is a short list of design manuals and other resources for further reading. APs who are not familiar with composting toilet or source separated wastewater systems should supplement reading of this Manual and these design manuals and resources, with hands on experience and training. APs are strongly advised to find a mentor to assist them with the learning process.

When referring to these manuals, follow the regulatory requirements of the SSR, *Environmental Management Act*, the BC Building and Plumbing Code, the standards and guidelines of this Manual and the BC SPM where these differ from those found in the design manuals or references.

When reading information on composting toilet processes, mulch basins and greywater systems, be aware of the climatic conditions that the information is related to.

- COTRA, *Guidance for Composting Toilet and Greywater Systems in BC*, 2016
http://onsitetechnicalresource.com/COTRA_CTG_Guidelines_R0_S.pdf
- U. Winblad, M. Simpson-Hébert, P. Calvert, P. Morgan, A. Rosemarin, R. Sawyer, J. Xiao, P. Ridderstolpe, S. AEsrey, J. Gough, and others, *Ecological Sanitation- revised and enlarged edition*, Stockholm Environment Institute, 2004. http://www.ecosanres.org/pdf_files/Ecological_Sanitation_2004.pdf
- D. D. Porto and C. Steinfeld, *The composting toilet system book: a practical guide to choosing, planning and maintaining composting toilet systems, a water-saving, pollution-preventing alternative*, 1.2 ed. Center for Ecological Pollution Prevention, 2000. A comprehensive manual on composting toilet systems, which includes details of and selection advice for specific composting toilet systems (proprietary and open source).
- J. C. Jenkins, *The humanure handbook: A guide to composting human manure*, 3rd. ed. Joseph Jenkins, Incorporated, 2005. <http://humanurehandbook.com/>
- B. Land, *SST Installation Guide*. USDA Forest Service, 2003.
<http://www.fs.fed.us/eng/pubs/pdf/03231303.pdf>
- C. Steinfeld and M. Wells, *Liquid Gold: The lore and logic of using urine to grow plants*. Green Frigate Books, 2004.
- A. Ludwig, *Create an oasis with greywater: your complete guide to choosing, building, and using greywater systems*. Oasis Design, 2000. <http://oasisdesign.net/> A comprehensive manual on greywater systems, including details of mulch basin and branched drain system design and installation. Website includes further information on greywater systems.
- EcoSanRes, <http://www.ecosanres.org/index.htm> with manuals for the use of urine and feces in agriculture as well as materials on source separation systems.
- Sustainable Sanitation and Water Management (SSWM) Toolbox <http://www.sswm.info/> also linked to the Sustainable Sanitation Alliance (SuSanA) Discussion Forum. SSWM provides dedicated web pages for specific technologies, including many relevant to this Manual. Technologies are described and illustrated, common advantages and disadvantages summarized and references provided.
- Guidelines for the safe use of wastewater, excreta and greywater. Volume 4: Excreta and greywater use in agriculture, World Health Organization 2006.
http://www.who.int/water_sanitation_health/wastewater/wastewateruse4/en/
- Health Canada, Government of Canada, "Canadian Guidelines for Domestic Reclaimed Water for Use in Toilet and Urinal Flushing", 16-Jul-2010.
http://www.hc-sc.gc.ca/ewh-semt/pubs/water-eau/reclaimed_water-eaux_recyclees/index-eng.php

- Government of Western Australia Department of Health greywater program.
http://www.public.health.wa.gov.au/3/667/2/greywater_pm
- Oregon State Department of Environmental Quality, greywater program information.
<http://www.deq.state.or.us/wq/reuse/graywater.htm>
- Washington State Department of Health, greywater program information and *Water Conserving Onsite Wastewater Treatment Systems RS&G*.
<http://www.doh.wa.gov/CommunityandEnvironment/WastewaterManagement/GreywaterReuse>
<http://www.doh.wa.gov/Portals/1/Documents/Pubs/337-016.pdf>
- *San Francisco Greywater Design Manual for Outdoor Irrigation*, <http://sfwater.org/index.aspx?page=100>

Cornell University composting information <http://compost.css.cornell.edu/science.html>

Bulk density calculator: <https://puyallup.wsu.edu/soils/bulkdensity/> Note that 1 lb per cubic yard = 0.59 Kg/ m³

D- 3 IN HOUSE GREYWATER REUSE FOR TOILET FLUSHING

D- 3.1 Introduction

Very light greywater (VLGW) is light greywater without laundry water. VLGW may be separately collected, treated and reused for toilet flushing in the house.

The system must meet the objectives of the BC Building and Plumbing Code, either through meeting acceptable solutions or via an approved alternative solution.

In house greywater reuse systems do not fall under the Sewerage System Regulation and are not filed as a sewerage system. This Appendix provides recommended standards that are consistent with the health protection objectives of this Manual.

Reclaimed water systems are managed under the Municipal Wastewater Regulation, in house greywater reuse systems are not "reclaimed water systems".

D- 3.2 Recommended standards for greywater reuse

Only very light greywater (VLGW) is to be used for in house recycling for toilet flushing. This is wastewater from showers, baths and hand basins only.

As VLGW contains contaminants and pathogens, specify the system and system operation and maintenance to provide, at minimum, the following risk barriers:

- Avoid risk of cross connection to potable water plumbing by physical, labeling and educational barriers
- Specify treatment with disinfection to meet standards
- Specify ongoing monitoring of treated water quality by an Authorized Person
- Provide education for the homeowner in risk management requirements
- Provide an alternative discharge method for the VLGW or for flows above those needed for reuse

Specify treatment objectives and disinfection standards for the system to meet, at minimum, Health Canada guidelines for domestic reclaimed water used in toilet and urinal flushing (see Section D- 3.4 for reference).

Specify, install and maintain reuse systems and system components to meet CAN/CSA-B128.3-12 (Performance of non-potable Water Reuse Systems) and CAN/CSA-B128.1-06/B128.2-06 (R2011) (Design and Installation of non-potable water systems/Maintenance and Field Testing of non-potable water systems).

System maintenance and monitoring is to include oversight by a qualified practitioner or professional if oversight is not provided by a government or local government body.

D- 3.3 Sewerage system standards for sites with greywater reuse

When planning a sewerage system for a building that reuses VLGW for toilet flushing, do not reduce SPM DDF for the system.

D- 3.4 Guidelines for greywater reuse

It is recommended that reuse systems only be installed if there is a management program in place to support ongoing monitoring and quality assurance for the system.

For information on reuse systems, water quality guidelines, monitoring recommendations and risk management, refer to Health Canada, Government of Canada, *“Canadian Guidelines for Domestic Reclaimed Water for Use in Toilet and Urinal Flushing”*, 16-Jul-2010. Or as updated.

Available: http://www.hc-sc.gc.ca/ewh-semt/pubs/water-eau/reclaimed_water-eaux_recyclees/index-eng.php

Ensure that the owner or system operator is aware of the need for ongoing system monitoring, including quality testing for the non-potable water, and is educated on risk management for the system.

D- 3.5 Guidelines for sewerage systems for sites with greywater reuse

The SPM DDF for a sewerage system serving the building is not reduced. This is because, despite the expectation of lower overall daily sewage volume from the building, total daily mass loading of contaminants will not be changed.

D- 4 BC BUILDING AND PLUMBING CODE AND COMPOSTING TOILETS

D- 4.1 Objective based code

The BC Building and Plumbing Code (BCBC) is an objective-based code which identifies the minimum standard within the Province of British Columbia for buildings to which the Code applies.

The code establishes objectives and functional statements to represent the required level of performance.

The code provides “acceptable solutions” which will result in achieving the performance objectives. This is similar to the approach taken by the BC SPM or this Manual.

For each acceptable solution, performance to be achieved is summarized as intent statement(s), with reference to the applicable objectives and functional statements that are addressed by the solution.

The BCBC also allows for:

“using alternative solutions, accepted by the authority having jurisdiction..., that will achieve at least the minimum level of performance required...in the areas defined by the objectives and functional statements attributed to the applicable acceptable solutions”

For residential construction the authority having jurisdiction is typically the local government building inspection department.

The BCBC addresses housing and small buildings in Part 9, providing a simplified set of solutions. In terms of health and safety, commercial buildings are addressed in Part 3.

D- 4.2 Part 3 buildings and composting toilets

For commercial buildings, for example a visitor center, Section 3.7.2 of the BCBC allows for the use of composting toilets or other methods (e.g. incinerating toilets):

“3.7.2.1. Plumbing and Drainage Systems

- 1) Except as permitted in Sentence (2), if the installation of a sanitary drainage system is not possible because of the absence of a water supply, sanitary privies, chemical closets or other means for the disposal of human waste shall be provided.
- 2) Waterless urinals are permitted to be used in buildings provided with a water supply.”

The solution will typically be engineered as part of the overall building engineering.

For comfort stations serving mobile homes, Section 3.7.2 requires water closet fixtures:

“3.7.2.4. Mobile Home Facilities

- 1) If mobile homes do not have individual sanitary facilities connected to a central water supply and drainage system, a service building shall be provided for public use.
- 2) The service building required by Sentence (1) shall contain
 - a) at least one water closet for each sex if the service building facilities serve not more than 10 mobile homes, and
 - b) an additional water closet for each sex for each additional 10 mobile homes.
- 3) If a service building is required by Sentence (1), it shall contain lavatories as required by Sentence 3.7.2.3.(1) and at least

- a) one laundry tray or similar facility, and
- b) one bathtub or shower for each sex.”

In this case provision of composting toilets instead of water closets will need to be based on an alternative solution, as for Part 9 buildings (see Section D- 4.4 below).

D- 4.3 Part 3 buildings and lavatories

For commercial buildings, for example a visitor center, Section 3.7.2 of the BCBC requires installation of lavatories (hand basins) in each room containing water closets or urinals:

“3.7.2.3. Lavatories

- 1) Except as permitted by Sentence (2), at least one lavatory shall be provided in a room containing one or 2 water closets or urinals, and at least one additional lavatory shall be provided for each additional 2 water closets or urinals.
- 2) Wash fountains in circular form are permitted to be provided in lieu of lavatories required by Sentence (1) provided each 500 mm of circumference is considered to be the equivalent of one lavatory.”

This may lead to a need to establish an alternative solution where a separate waterless urinal is provided ancillary to a composting toilet installation.

The alternative solution will need to address the following performance requirements.

D- 4.3.1 INTENT, FUNCTIONAL STATEMENTS AND OBJECTIVES RELATING TO SECTION 3.7.2.3

D- 4.3.1.1 Objective

Section 3.7.2.3(1) of the BC Building Code is based generally on the Objective OH2, Sanitation:

“An objective of this Code is to limit the probability that, as a result of the design or construction of the building, a person in the building will be exposed to an unacceptable risk of illness due to unsanitary conditions. The risks of illness due to unsanitary conditions addressed in this Code are those caused by—

- OH2.1 - exposure to human or domestic waste
- OH2.2 - consumption of contaminated water
- OH2.3 - inadequate facilities for personal hygiene
- OH2.4 - contact with contaminated surfaces
- OH2.5 - contact with vermin and insects”

And is based particularly on OH2.3.

D- 4.3.1.2 Attribution

The section is based on functional statement:

- F71 To provide facilities for personal hygiene.

And on risk objective:

- OH2.3 - inadequate facilities for personal hygiene

D- 4.3.1.3 Intent

The intent of the section is to:

“To limit the probability of an insufficient number of lavatories, which could lead to the inability of persons to use lavatories in a timely manner, which could lead to an inability to maintain personal hygiene, which could lead to harm to persons.”

D- 4.3.2 RECOMMENDED ALTERNATIVE SOLUTION

The Manual of Composting Toilet and Greywater Practice establishes that composting toilet facilities which have no water supply are to be provided with an alternate method for hand sanitizing that meets the performance objectives of the BC Building Code. The recommended method is to install a hand sanitizer dispenser. The Manual establishes that the hand sanitizer should meet recommendations of the US FDA and Health Canada and provides reference to these recommendations and testing methods together with performance objectives in rationale statements.

Other methods may be practical, if they meet an equivalent performance objective. Systems using wipes are discouraged due to potential issues with disposal of the wipes to the composting toilet.

The following generic alternative solution wording is provided to satisfy the functional statements and objectives of the BC Building Code. The alternative solution is based on identifying the need for a hand sanitizing method that does not require the use of water.

D- 4.3.3 ALTERNATIVE SOLUTION MEETS INTENT, FUNCTIONAL STATEMENTS AND OBJECTIVES

D- 4.3.3.1 Intent

This alternative solution is intended to address the need for an adequate hand sanitizing method in the absence of water supply.

A spray, foam, gel or liquid hand sanitizer in a fixed dispenser provides this adequate sanitation facility.

D- 4.3.3.2 Functional statements

F71 To provide facilities for personal hygiene.

The hand sanitizer will provide this facility.

D- 4.3.3.3 Objectives

The base objective is OH-2, Avoid unacceptable risk of illness due to unsanitary conditions.

The hand sanitizer meets objective OH2.3, by providing adequate facility for personal hygiene in the absence of water supply.

D- 4.4 BC Building Code Section 9.31

For Part 9 buildings, Section 9.31 of the BC Building Code requires that all dwellings be connected to a potable water supply, and requires that, where piped water supply is available, every dwelling unit be provided with fixtures including a water closet.

“9.31.4.1. Required Fixtures

- 1) A kitchen sink, lavatory, bathtub or shower, and water closet shall be provided for every dwelling unit where a piped water supply is available. ”

Further, the Building Code expects human waste to be discharged via a sanitary drainage system to a private sewage disposal system:

“Private sewage disposal system means a privately owned plant for the treatment and disposal of sewage (such as a septic tank with an absorption field).”

Where a composting toilet is used in lieu of a water closet to handle and dispose of human waste an alternative solution will need to be documented to meet the objectives otherwise met by a water closet and associated plumbing. This alternative solution will need to achieve at least the minimum level of performance required (as expressed in the BCBC objectives and functional statements).

Further, it is not adequate to consider a composting toilet as a "fixture", since the composting toilet will necessarily not meet the requirements for a "fixture" under the BC Plumbing Code, and may not be connected to water supply and or sanitary drainage piping.

The alternative solution will need to address the following performance requirements.

D- 4.4.1 INTENT, FUNCTIONAL STATEMENTS AND OBJECTIVES RELATING TO SECTION 9.31

D- 4.4.1.1 Objective

Section 9.31.4.1 of the BC Building Code is based generally on the Objective OH2, Sanitation:

“An objective of this Code is to limit the probability that, as a result of the design or construction of the building, a person in the building will be exposed to an unacceptable risk of illness due to unsanitary conditions. The risks of illness due to unsanitary conditions addressed in this Code are those caused by—

- OH2.1 - exposure to human or domestic waste
- OH2.2 - consumption of contaminated water
- OH2.3 - inadequate facilities for personal hygiene
- OH2.4 - contact with contaminated surfaces
- OH2.5 - contact with vermin and insects”

And particularly on OH2.1 and OH2.3.

D- 4.4.1.2 Attribution

The section is based on functional statements:

- F70 To provide potable water.
- F71 To provide facilities for personal hygiene.
- F72 To provide facilities for the sanitary disposal of human and domestic wastes.

And on risk objectives:

- OH2.1 - exposure to human or domestic waste
- OH2.3 - inadequate facilities for personal hygiene

D- 4.4.1.3 Intent

The intent of the section is to:

“To limit the probability of inadequate sanitation facilities, which could lead to an inability to maintain personal hygiene, which could lead to harm to persons.”

D- 4.4.2 RECOMMENDED ALTERNATIVE SOLUTION

The Manual of Composting Toilet and Greywater Practice provides the following generic alternative solution wording to satisfy the functional statements and objectives of the BC Building Code by installation of a composting toilet system. The alternative solution is based on:

- Identifying the composting toilet as or as part of a “private sewage disposal system”, in this case as a part of a sewerage system under the Sewerage System Regulation (SSR), filed with the local Health Authority and maintained under the requirements of the SSR.
- Clarifying that all wastewater flows from the dwelling unit would flow, via a sanitary drainage system, to a “private sewage disposal system”, in this case as a sewerage system under the Sewerage System Regulation (SSR), filed with the local Health Authority and maintained under the requirements of the SSR.
- Documentation in the filed rationale of system selection to meet the objectives of this Manual and the BC Building Code.

D- 4.4.3 STANDARD PRACTICE

The Sewerage System Regulation defines standard practice as:

“**standard practice**” means a method of constructing and maintaining a sewerage system that will ensure that the sewerage system does not cause, or contribute to, a health hazard”

The Manual of Composting Toilet and Greywater Practice is intended to provide a source of standard practice, so that Authorized Persons who follow the Manual and plan, construct and maintain composting toilet systems in conformance with the Manual are ensuring the composting toilet does not cause, or contribute to, a health hazard.

This Manual provides standards which are outcome (performance) based and based on scientific rationale as well as being representative of standard practice in the industry in North America. Stated outcomes in the Manual are consistent with the health protection objectives of the BC Building Code as well as the SSR.

The Manual’s standards and guidelines, based on defined performance objectives, provide the evidence to support the proposed alternative solution.

D- 4.4.4 ALTERNATIVE SOLUTION MEETS INTENT, FUNCTIONAL STATEMENTS AND OBJECTIVES**D- 4.4.4.1 Intent**

The intent is to provide adequate sanitation facilities.

This alternative solution is intended to remove the need to install a water closet and plumbing for a water closet in a dwelling unit by providing an equivalent.

A composting toilet is an alternative method of providing an adequate sanitation facility. The composting toilet is adequate because it is to be designed, installed and maintained following the Manual to convey and dispose of human waste without causing a health hazard. This facility forms part of a “private sewage disposal system” (a sewerage system under the SSR).

The composting toilet is designed, installed and operated to meet the functional performance statements and objectives cited in support of the intent of section 9.31.4.1 of the BC Building Code.

D- 4.4.4.2 Functional statements

The functional statements are; F71 To provide facilities for personal hygiene and F72 To provide facilities for the sanitary disposal of human and domestic wastes.

The composting toilet provides a facility to allow hygienic handling of human waste. The standards of the Manual mandate that composting toilets be planned, specified and installed to avoid contact with waste (for the user), to minimize contact with waste (for the maintenance provider) and to secure the stored waste from access (outside of during maintenance). The facility is filed under the Sewerage System Regulation (SSR) by an Authorized Person as defined by the SSR. Maintenance of the facility is required by the SSR.

Authorized persons will plan, construct and maintain the composting toilet system following the Manual of Composting Toilet and Greywater Practice. The Manual includes specific documentation standards for operation and maintenance plans, which are to include procedures for safe operation of the facility.

Composting toilet construction and maintenance standards of the Manual address additional functional objectives:

- F81 To minimize the risk of malfunction, interference, damage, tampering, lack of use or misuse
- F82 To minimize the risk of inadequate performance due to improper maintenance or lack of maintenance.

D- 4.4.4.3 Objectives

The base objective is OH-2, Avoid unacceptable risk of illness due to unsanitary conditions.

The composting toilet is designed and constructed to avoid exposure to human waste (other than during maintenance), to contain the waste and prevent vector or human access to the waste while it is being processed. This meets objective OH2.1

The Manual of Composting Toilet and Greywater Practice establishes minimum standards for design, construction and maintenance of composting toilets in order to avoid the creation of a health hazard (as defined in the SSR). This meets objective OH2.3, by providing an adequate sanitation facility, as described above.

Though each system has different design features, common elements include screened venting, secured compost processors, impermeable tested chambers to safe guard against leakage, durable and washable surfaces as would be expected in any facility or fixture that requires regular cleaning. The separation from the potable water system ensures that cross connection or contamination of potable water is not possible.

The composting toilet provides protection from human contact with waste and an adequate facility for personal hygiene that is equivalent to a water closet.

The Manual specifically identifies the following primary purposes for the composting toilet system:

- Safely and hygienically collect and contain human waste
- Manage odors and prevent vector or human access during storage
- Manage leachate and safely discharge leachate or diverted urine to a combined or source separated sewerage system
- Provide for safe and practical management of residual organic matter.

And establishes that the Authorized Person is to document the selection of a system to meet these objectives.

D- 4.4.5 SUMMARY

The Manual of Composting Toilet and Greywater Practice has been developed by the BC Ministry of Health to meet the growing demand for alternative non water-borne waste collection, treatment and discharge systems that conserve potable water.

Planning, construction and maintenance standards of the Manual have been developed to result in composting toilets filed under the Sewerage System Regulation which meet stated performance objectives, matching those of the BC Building and Plumbing Code.

These objectives are supported by in depth by the Manual, with standards, rationale and guidance governing aspects that cover hygiene, safety, security of potable water, and security from vermin and unauthorized contact with waste.

Until a point in time when the Composting Toilet receives status as a defined option within the BC Building code, we present this as an alternative solution based on which a building official may wish to accept and understand it use as an equivalent to a water closet.

D- 5 OPERATION VERSUS MAINTENANCE FOR COMPOSTING TOILET SYSTEMS

Table D- 1 illustrates a typical division of responsibility between operation of the composting toilet system and tasks which would be undertaken by or be directly supervised by an Authorized Person acting as the maintenance provider.

These examples are intended to indicate the minimum level of involvement of the AP. Based on the individual system the system maintenance plan may specify a greater level of involvement by the AP. For very simple systems with off-site discharge of residual organic matter, the maintenance plan may specify reduced AP involvement. In some cases, the owner may wish to engage an AP to undertake the majority of operation tasks.

Table D- 1. Examples of operation versus maintenance

TASK	OPERATION (OWNER)	MAINTENANCE PROVIDER
Composting toilet and collection system	Addition of bulking agent, moisture management, cleaning	<ul style="list-style-type: none"> ○ Scheduled checks on integrity of unit, venting, vector access, operational issues ○ Repairs or modifications
Composting toilet processor	Collection of monitoring data, moisture management, operation of mechanical mixing, vector management	<ul style="list-style-type: none"> ○ Review of monitoring data ○ Scheduled checks on process and physical unit(s) ○ Scheduled checks on storage location and leachate management ○ Repairs or modifications
On-site burial	<ul style="list-style-type: none"> ○ Collection of process and monitoring data and notification of maintenance provider ○ May participate in burial. ○ Planting and ongoing protection of burial location 	<ul style="list-style-type: none"> ○ Solvita and or analytical quality testing of residual organic matter, with review of monitoring and process records prior to approval for discharge ○ Implementation of burial at sites pre-determined during system design. ○ Marking and drawing record of burial location, with update to filed maintenance plan after burial
Maintenance plan	<ul style="list-style-type: none"> ○ Following the operation instructions in the system manual ○ Notifying maintenance provider in case of performance or other issues 	<ul style="list-style-type: none"> ○ Regular maintenance or maintenance supervision following the schedule in the plan ○ Monitoring and adjustment of the process based on the plan and performance standards in the plan ○ Adjustments and updates to the plan
Responsibility	<ul style="list-style-type: none"> ○ Responsible under the SSR for operation and maintenance of the system ○ Operates system following the maintenance plan ○ Engages Authorized Person as maintenance provider 	<ul style="list-style-type: none"> ○ Maintenance and monitoring of the system following the maintenance plan ○ Reporting to the owner ○ Updates to the maintenance plan ○ May supervise the owner in maintenance tasks

D- 6 SUMMARY FOR ENVIRONMENTAL HEALTH OFFICERS

D- 6.1 Introduction

The Manual of Composting Toilet and Greywater Practice has been developed by the Ministry of Health as a source of standard practice for implementation of composting toilet systems and source separated wastewater systems in BC. The Manual is intended to supplement and to be used with the BC Sewerage System Standard Practice Manual (SPM).

This Section provides a short introduction to the Manual, and summarizes what is to be expected in a complete filing for a composting toilet or source separated wastewater system.

D- 6.1.1 SEWERAGE SYSTEM REGULATION

The Manual applies to planning, installation and maintenance of composting toilets and source separated wastewater systems as onsite sewerage systems under the Sewerage System Regulation (SSR).

The Manual provides standards for documentation of systems and information on filing under the SSR.

D- 6.2 Onsite waste management

Composting toilet systems provide an alternative, primarily non-water borne, management option for human excreta. Source separated wastewater systems manage wastewater flows from a building where those flows have been separated to one or more streams.

A typical onsite system for a residence will consist of one or more composting toilet systems plus a source separated wastewater system.

The system standards specified by the Manual are based on protection of health. Standards are based on those of the SPM, with adjustments for the specific nature of these systems. Horizontal separation standards for discharge areas follow those of the SPM. A rationale for the standards is provided in Part D Section D- 1 and is consistent with the rationale for SPM standards.

D- 6.3 Composting toilet system filings

Composting toilet systems include the composting toilet pedestal, conveyance system and the composting processor. The processor may be as a part of a unit, or may be separate.

After treatment in the composting toilet system, residual organic matter (effluent) may be managed in three ways:

- Off-site discharge to an approved facility, as for septic tank or treatment plant sludge.
- On-site discharge by on-site burial, under the SSR as for other effluent.
- On-site discharge by on-site surface discharge, meeting the *Environmental Management Act (requires a professional)*.

Vault toilet systems are not considered to be composting toilet systems. If vault toilets are installed on the same site as a sewerage system or systems (e.g. a greywater system), flows to the vault toilet systems are considered separately from those to the sewerage system(s).

D- 6.3.1 PRIMARY PURPOSES OF COMPOSTING TOILET SYSTEMS

The Manual establishes the following primary purposes for composting toilet systems, which are to be met in all cases:

- Safely and hygienically collect and contain human waste
- Manage odors and prevent vector or human access during storage
- Manage leachate and safely discharge leachate or diverted urine to a combined or source separated wastewater sewerage system
- Provide for safe and practical management of residual organic matter.

D- 6.3.2 COMPOSTING TOILET SYSTEM FILINGS

Composting toilet systems will be filed as "Type 1" systems. Associated source separated wastewater systems may be either Type 1, 2 or 3 depending on the treatment method specified.

A complete composting toilet system filing will include, at minimum, the following key information:

- Information on the owner, site and use in conformance with the SSR.
- A declared design flow which may be either:
 - The estimated average daily excreta volume, or
 - The SPM equivalent daily design flow (where the system is filed with a wastewater system)
- Rationale for the selected design flow and statement of collection and treatment capacity for the system
- Planned discharge method for residual organic matter
- Rationale for selection of a particular composting toilet system
 - To meet the primary purposes for composting toilet systems
 - To meet secondary objectives, including those for the chosen discharge method
- Specifications for the composting toilet system
- If on-site discharge is specified:
 - Site and soil evaluation information meeting SPM standards
 - Rationale for selection, sizing, vertical and horizontal separations of the discharge system
 - Plans and specifications for the discharge system
- The source of standard practice followed
- Information on and seal of the Authorized Person, in conformance with the SSR.

Composting toilet system filings may or may not include a wastewater system in the filing. If the filing does not include a system to receive wastewater flows (including any leachate from the composting toilet system) then the filing documentation should include details of the wastewater system to be used for those flows. If that wastewater system is an onsite sewerage system, the documents should include information on the existing permit or filing for that system and confirm that the system is functional.

If the system being filed does not include any wastewater discharge, and residual organic matter is planned to be discharged off-site, soils and discharge area horizontal separation information may be shown as "NA" (not applicable) on a filing form or in the filing documentation.

D- 6.4 Source separated wastewater system filings

The most common source separated streams are:

- Light greywater (from all household plumbing uses other than WCs, kitchen sinks and dishwashers and mop sinks)
- Combined greywater (from all household plumbing uses other than WCs)
- Urine
- Leachate (from composting toilet systems)

Mulch basin systems are a special type of source separated wastewater system in which small flow residential light greywater or diluted urine is diverted and used for subsurface irrigation during the irrigation season only. In this case the Manual allows for the diverted light greywater to be applied to mulch basins without the use of a septic tank, combining treatment and dispersal in the mulch basin.

D- 6.4.1 SOURCE SEPARATED WASTEWATER SYSTEM FILINGS

Source separated wastewater system filings are as for combined sewage wastewater systems, and filing documentation should provide the same information as specified in the SSR and SPM for sewerage systems.

Seasonal systems may base soil evaluation on dry season conditions.

The Manual provides specific standards for declaration of design flows, in Section C- 2.2.1.

The wastewater system may be filed alone, or may be included in the same filing as a composting toilet system. In the case of seasonal diversion systems, a source separated wastewater system may be filed on a site that is otherwise serviced by a sewer connection or an existing onsite sewerage system. In some cases, a source separated wastewater system may be used to serve part of the flows from a building that has an existing onsite sewerage system.

If the filing does not include a system to receive human excreta (e.g. a composting toilet system) then the filing documentation should include details of the system to be used to manage excreta. If that is an onsite sewerage system, the documents should include information on the existing permit or filing for that system and confirm that the system is functional.

D- 6.4.1.1 Mulch basin seasonal diversion system filings

If a mulch basin system is filed without other wastewater systems, the system may not include a septic tank.

The filing documentation should, in addition to normal filing documentation, identify:

- The SPM equivalent daily design flow for the site and use (to be 2400 L/day or less except where discharge is of urine diluted with fresh water only)
- The alternative discharge method to be used for the light greywater when not being diverted for irrigation.
- The treatment and discharge method(s) used for other site flows and human excreta (e.g. sewer, onsite sewerage system).
- In the case of an existing onsite sewerage system being the alternative discharge method, the permit or filing for the system and confirmation that the system is functional.

Note that the Manual provides for seasonal diversion systems for other greywater or for higher flows, filings for these systems should include these same items except for the daily design flow limit.